

# **Chemical Feed Flowmeter** **Series S6A**



**ProSeries<sup>®</sup>**  
**by Blue-White Ind.**  
**Blue-White.com**

Installation and Operating Manual

## TABLE OF CONTENTS

<u>Section</u>	<u>Heading</u>	<u>Page</u>
1.0	Introduction . . . . .	3
1.1	Product Overview . . . . .	3
2.0	Product Specifications . . . . .	3-5
2.1	Features . . . . .	6
2.2	Agency Listings . . . . .	6
3.0	Unpacking . . . . .	6
4.0	Installing Blue-Central® . . . . .	6
5.0	Connecting the Meter . . . . .	6
6.0	Configuration . . . . .	7
6.1	Dashboard . . . . .	7
6.2	Settings . . . . .	7
6.2.1	Edit Settings . . . . .	7
6.3	About Screen . . . . .	7
6.4	Device Summary . . . . .	8
6.5	Setup and Configure . . . . .	8
6.5.1	General . . . . .	9
6.5.2	Faults and Warnings . . . . .	10
6.5.3	Relay Output . . . . .	11
6.5.4	Frequency Output . . . . .	12
6.5.5	4-20 mA Output . . . . .	12
6.5.6	Pulse Output . . . . .	13
6.5.7	Saving . . . . .	13
7.0	Upgrade Firmware . . . . .	14
8.0	Factory Reset . . . . .	15
9.0	Digital Drawdown . . . . .	16
9.1	Customize Chemical Calibration . . . . .	17-19
10.0	System Information . . . . .	20
11.0	Wiring Installation . . . . .	21
11.1	Cable Gland Liquid-Tight Connections . . . . .	21
11.2	Wiring Terminal . . . . .	21
11.3	FVS Wiring Guide - S6A to ProSeries Pump . . . . .	22-23
12.0	S6A Remote Mount Display . . . . .	24
12.1	Remote Mount Display Terminal Configuration . . . . .	24
12.2	Wiring S6A Remote Mount Display to S6A Meter Body . . . . .	25
13.0	Programming the S6A Remote Mount Display . . . . .	26
13.1	S6A Meter Frequency Output Signal Configuration . . . . .	26
13.2	S6A Remote Mount Display Configuration . . . . .	26
13.2.1	S6A Suggested Default Display Calibration Constants . . . . .	27
13.2.2	Determine the Decimal Rate Factor . . . . .	27
13.2.3	Calculate the Rate Scale Factor . . . . .	27
13.2.4	Determine the Decimal Total Factor . . . . .	28
13.2.5	Calculate the Time Factor . . . . .	28
13.2.6	Calculate the Total Scale Factor . . . . .	28
14.0	Programming S6A Remote Mount Display (step by step guide) . . . . .	29
15.0	Installation . . . . .	30
15.1	Mounting Location . . . . .	30-31
15.2	Product Dimensions . . . . .	31
16.0	Maintenance and Service . . . . .	31
17.0	LCD Display for Meter Mount Display Model . . . . .	32
18.0	Status LED for Remote Mount Display Model . . . . .	33
19.0	Troubleshooting . . . . .	33
20.0	Replacement Parts . . . . .	34
21.0	Product Matrix . . . . .	35
	Warranty . . . . .	36

**PLEASE READ ENTIRE INSTRUCTION MANUAL PRIOR TO INSTALLATION AND USE.**

## 1.0 Introduction

Thank you for purchasing the S6A Chemical Feed Flowmeter.

This Operating Manual provides important information regarding the safe installation, operation, and maintenance of the meter. Please read it carefully before attempting to install or operate the meter. A copy of this Manual should be kept by the operator. Extra copies of this Manual are available from your supplier or directly from the manufacturer.

Questions regarding the safe use of this product and other technical assistance may be directed to:  
**Blue-White Ind. PH: 714-893-8529 email: techsupport@blue-white.com**

## 1.1 Product Overview

The S6A Chemical Feed Flowmeter is designed to accurately verify chemical feed.

## 2.0 Product Specifications

### General Operation:

#### Compatible Fluid Types:

Acoustically conductive fluids  
 Particulate and bubbles with 50,000 ppm or less

#### Pre-Calibrated Chemical Profiles:

Water  
 Aqueous Ammonia  
 Ammonium Hydroxide  
 Ferric Chloride 40%  
 Sodium Bisulfite 40%  
 Sodium Hypochlorite 12.5%  
 Sodium Permanganate  
 Hydrofluorosilicic Acid 25%  
 Ammonium Sulfate 10%

### Inline Pipe Fitting/Transducer:

#### Transducer

PEEK

#### Pipe Fitting

PVDF (optional PVC)

#### PVDF Connections

Maximum fluid temperature: 14°F to 130°F (-10°C to 54°C)  
 Maximum operating pressure: 200 PSI/g at 70°F

#### PVC Connections

Maximum fluid temperature: 14°F to 130°F (-10°C to 54°C)  
 Maximum operating pressure: 200 PSI/g at 60°F

### Temperature Vs. Pressure Chart:

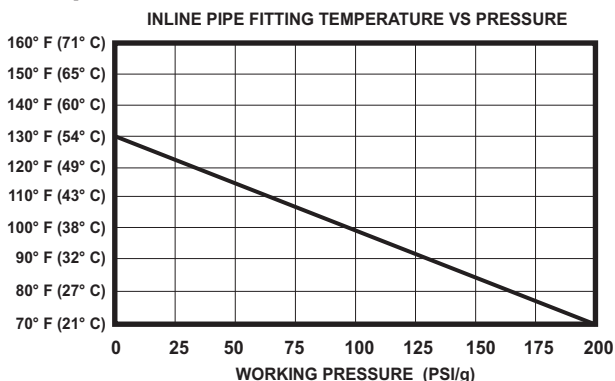

### SPU (Signal Processing Unit):

#### Enclosure

NEMA 4X (IP66) Polycarbonate, SS hardware.  
 Dimensions: 10.02H x Ø3.79 inches (254.5H x Ø96.1 mm)  
 Weight 1.5 lb. (.68 Kg.)

#### Power Requirements

5V VDC; 5 watts maximum

#### Environmental Conditions

Operating temp: 14°F to 104°F (-10°C to 40°C)  
 Storage: -40°F to 158°F (-40°C to 70°C)  
 Relative humidity: 0% - 90%

#### Software Language

English

#### Volume Units

Independently configurable Rate and Total units in: U.S. Gallons, Liters, or Milliliters.

#### Time Units

Seconds, minutes, hours, days.

#### Flow Rate Averaging

Selectable: 1, 4, 8, 16, and 32 seconds.

#### Data Outputs

- Isolated 4-20 mA output - fully configurable
- 0-10000 Hz Pulse output - fully configurable

#### Process Control

One Solid State Relay

Load capacity: 24V, 100mA max (ext. supplied)

- Configure to flow rate for high/low/range rate trigger. Programmable release values enable auto release or manual latching operation.
- Configure to flow total for automatically triggered, timed batch operations for proportional feed applications.

#### Power Supply (user configurable)

Includes each of the following:

U.S. Transformer, 115VAC 60HZ / 5VDC, NEMA 5/15 plug  
 Europe Transformer, 230VAC 50HZ / 5VDC, CEE 7/11 plug  
 Australia / New Zealand Transformer, 240VAC 50HZ / 5VDC, AS 3112 plug  
 U.K. Transformer, 230VAC 50Z / 5VDC, BS 1363/A plug

### Blue-Central® Software

#### Compatible Operating Systems

Windows 7, 8, and 10  
 Mac (OSX 10.11/10.12/10.13)

#### Computer Connector

USB-A to USB-C (Included)



**Blue-Central®**

## 2.0 Product Specifications (continued)

### Accuracy Charts:

#### S6A1 ACCURACY RANGE

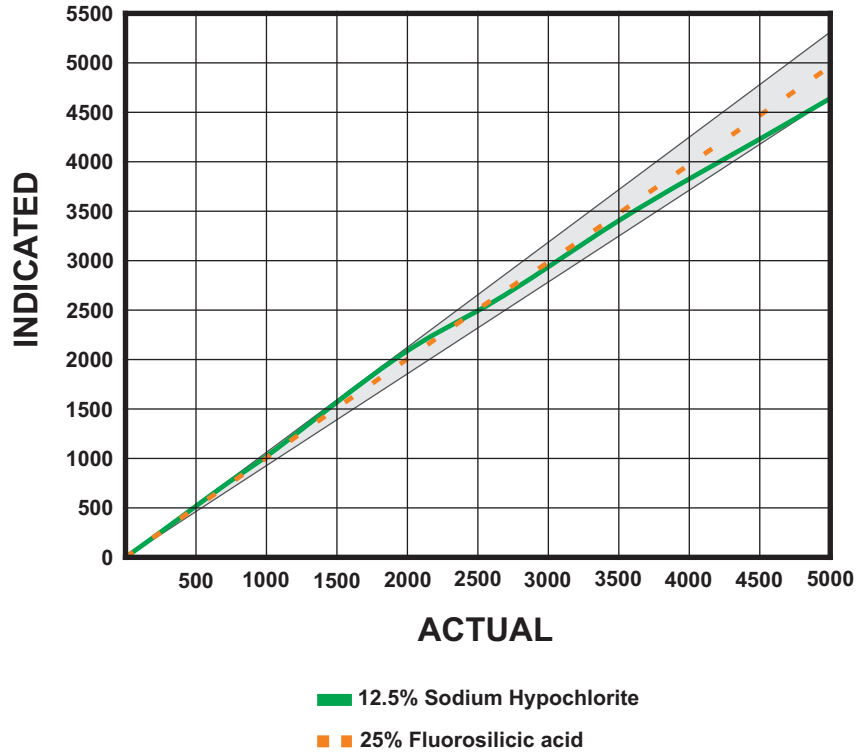

#### S6A2 ACCURACY RANGE

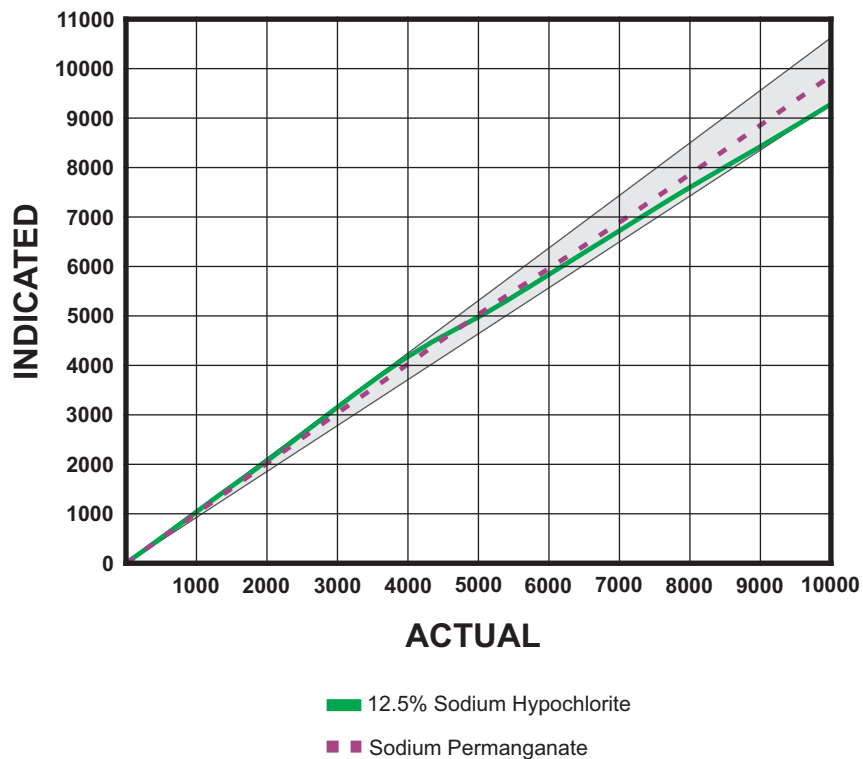

### Digital Drawdown Accuracy Charts:

Below are the meter accuracy charts after a Digital Drawdown has been performed (see page 16, section 9.0).

#### S6A1 DIGITAL DRAWDOWN ACCURACY

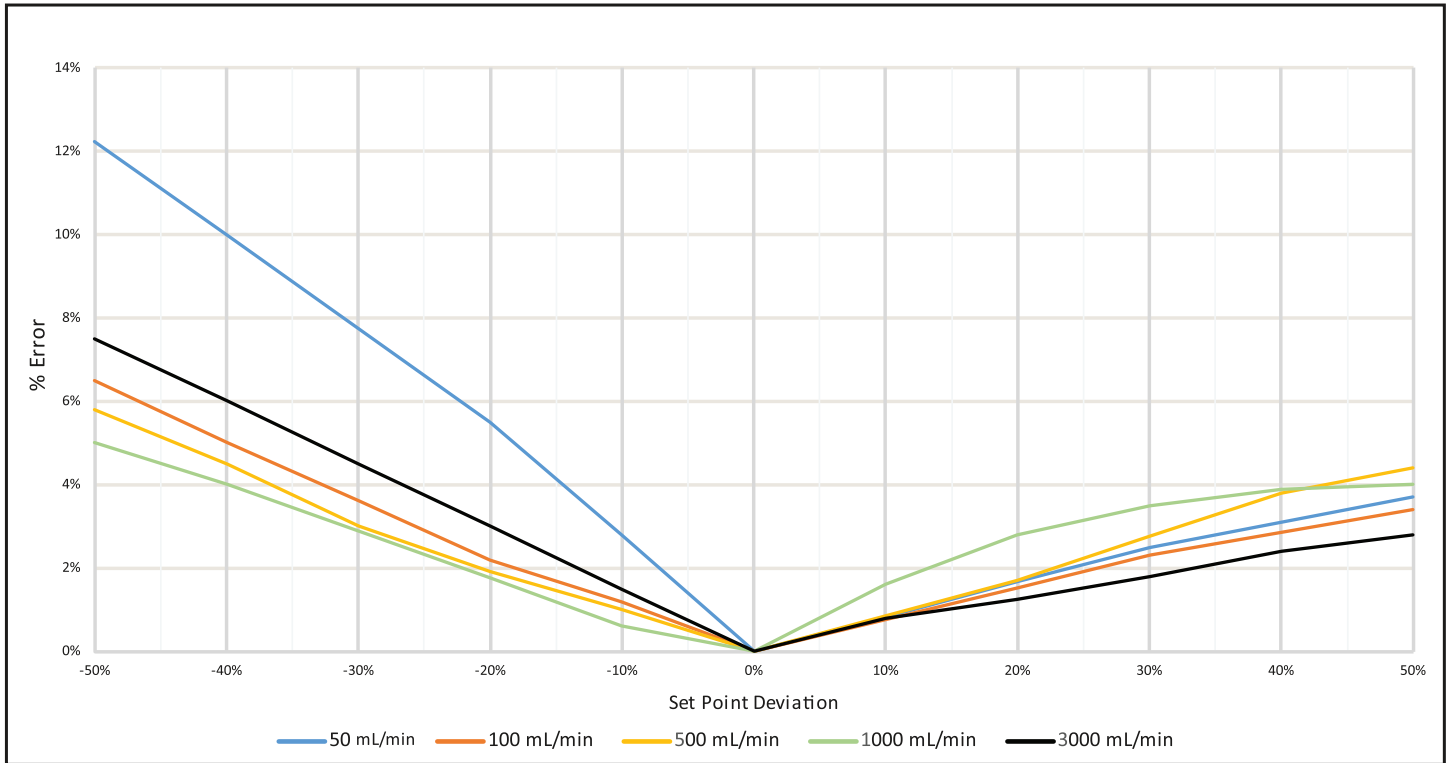

#### S6A2 DIGITAL DRAWDOWN ACCURACY

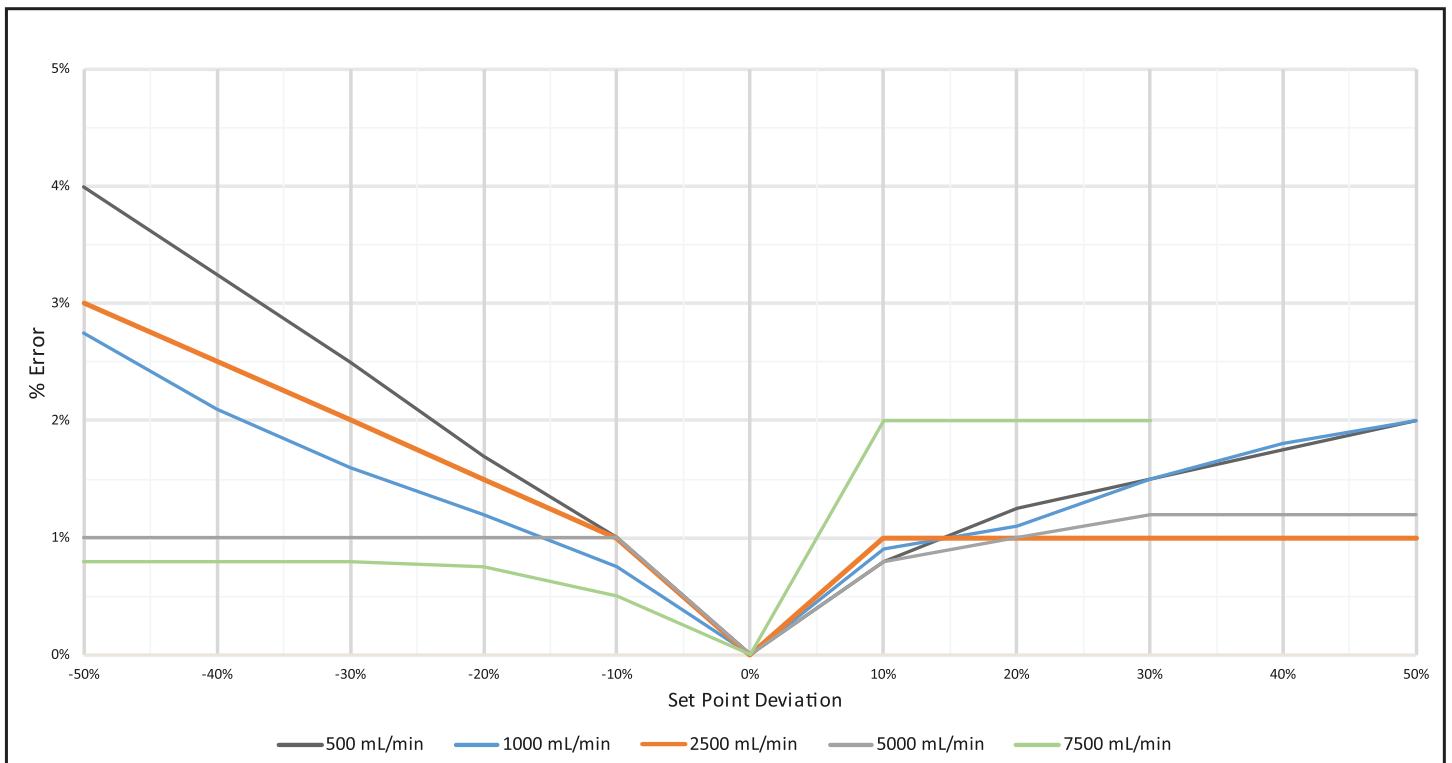

## 2.1 Features

- Inline pipe fittings for easy installation
- Configurable via Blue-Central® desktop software
- Isolated 4-20 mA output - fully configurable
- 0-10000Hz Pulse output - fully configurable
- User configurable flow rate and total set-point triggers
- Flow-rate readings as low as 10 mL/min
- Included wetted end fittings allow for more than 14 inlet and outlet configurations
- True unions for ease of maintenance
- Wetted components constructed out of PVDF and PEEK
- Quick visual inspection with built in status LED light
- Process control via configurable solid state relay, which can be configured to close or open trigger at a flow-rate or to flow total for batching operation
- NEMA 4X (IP66) Washdown

## 2.2 Agency Listings



This meter is certified to NSF/ANSI Standard 61 - Drinking Water System Components - Health Effects

## 3.0 Unpacking

The S6A Chemical Feed meter is shipped with the following contents:

- S6A Chemical Feed meter
- meter Body Connection Fittings
- 3/16" Hex Key
- Flash Drive (Operating Manual and **Blue-Central**®)
- USB-A to USB-C connector
- Power Supply (user configurable)

The S6A was designed to be installed and operated by qualified personnel only. Do not attempt to install or operate the meter if you are unsure. Seek qualified assistance. Please note that warranty coverage does not include damage due to misuse or improper installation.

## 4.0 Installing Blue-Central®

To configure the S6A, Blue-Central® must be installed and running on a desktop or laptop computer. Blue-Central® is Blue-White's proprietary software application. To install Blue-Central®, power on the desktop or laptop computer and insert the provided USB Flash Drive. Doubleclick the .exe file to install and run the Blue-Central® Application. Blue-Central® allows the user to update firmware as well as view the meter's device details.

**Note:** Installing Blue-Central® will add a shortcut to the desktop screen.



## 5.0 Connecting the Meter

**Meter Mounted Display Model:** Connect the meter to the desktop or laptop computer with the provided USB to USB-C cable. The meter will appear on the Blue-Central® dashboard.

**Remote Mounted Display Model:** To connect the meter to the desktop or laptop computer, open the enclosure by removing the four screws with the provided 3/16" hex key. Next connect the provided USB to USB-C cable from the desktop or laptop computer to the USB-C connector located on the meter's wiring terminal. The meter will appear on the Blue-Central® dashboard.

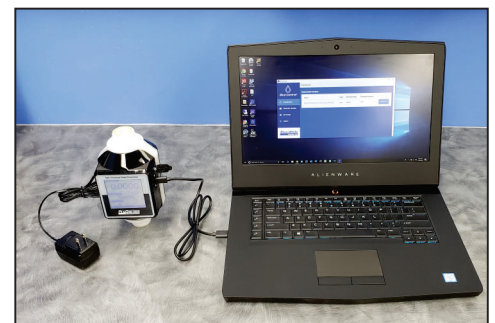

**Note:** A power supply is not needed to configure the meter.

## 6.0 Configuration

Once Blue-Central® has been installed and the meter has been connected to the desktop or laptop computer it is recommended that the user perform a configuration. The following section details the meter configuration process.

**Note:** The meter will work without performing a configuration.

### 6.1 Dashboard

The Dashboard allows the user to manage devices connected to Blue-Central®. From here the user can view the Name, Type, Model Number, and Firmware Version of any meter listed under Connected Devices. The user can also access the Device Summary screen (section 6.4) by hovering the mouse cursor over the Actions button or left-clicking the corresponding meter's name under Connected Devices.

**Note:** Each meter listed under Connected Devices will have its own corresponding Actions button.

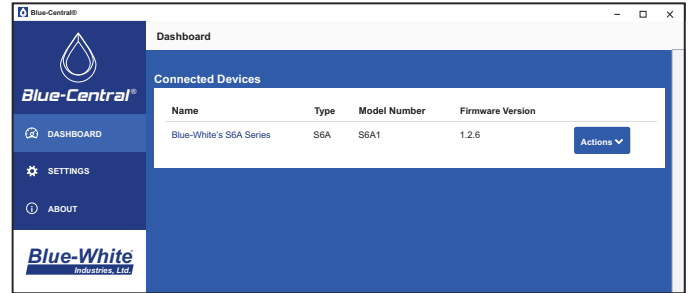

Dashboard

### 6.2 Settings

Click Settings on the left sidebar to be taken to the Edit Settings screen.

From the Edit Settings screen the user can select the Unit of Volume and Unit of Time.

**Note:** These settings are universal to all meters being configured under Connected Devices.

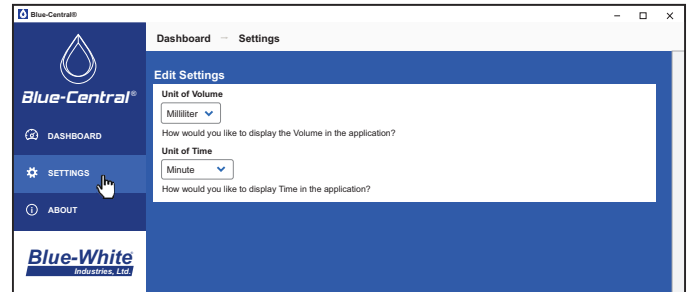

Edit Settings

#### 6.2.1 Edit Settings

**Unit of Volume:** Edit the Unit of Volume by left-clicking the drop-down menu. Select from Milliliters, Liters, and US Gallons.

This selected value will be used as the volumetric unit of measure for the total flow and flow-rate calculation for all S6A meters connected to Blue-Central®. Factory Default: Milliliter

**Unit of Time:** Edit the Unit of Time by left-clicking the drop-down menu. Select from Seconds, Minutes, Hours, and Days.

This selected value will be used as the time unit of measure for flow-rate calculation for all S6A meters connected to Blue-Central®. Factory Default: Minute

**Note:** Any changes to settings will be saved automatically.

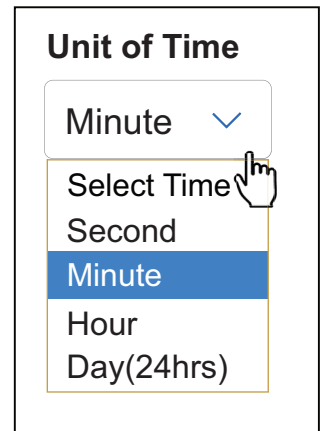
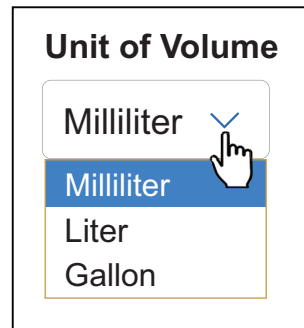

### 6.3 About

Click About on the left sidebar to be taken to the About screen.

Here the user can view details about Blue-Central® and contact information for Blue-White Industries, as well as submit feedback by left-clicking the Share your Ideas and Feedback link provided.

**Note:** There is also a link for Blue-Central® API for advanced users.

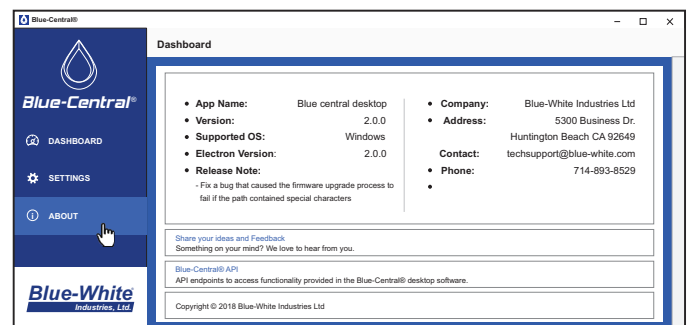

About

### 6.4 Device Summary

The Device Summary screen gives the user a basic overview of the meter’s settings and status.

To access the meter’s Device Summary screen, left-click the device name. Alternatively, the user can hover the mouse cursor over the corresponding Action button on the Dashboard and left click Device Summary on the drop-down menu.

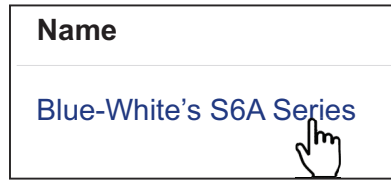

OR



From the Device Summary screen the user can view the meter’s current Feed Rate (1), Totalized Flow (2), any Warnings and/or Faults (3), Chemical Profile (4), Digital Drawdown status (5), and the current Firmware Version (6).

**Note:** Under Totalized Flow (2), the user can toggle between All Time for the flow total for the lifetime of the meter or Since Power Up for the flow total since the meter’s last power cycle.

The Device Summary screen features a side bar (7) which allows the user to navigate to the following screens: Setup (section 6.5), Digital Drawdown (section 9.0), Upgrade Firmware (section 7.0), Factory Reset (section 8.0), and System Information (section 10.0).

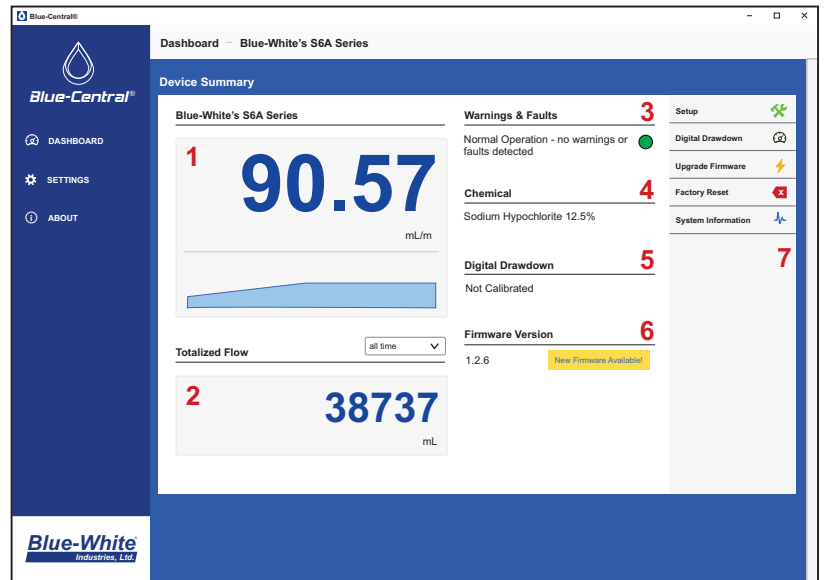

Device Summary

### 6.5 Setup and Configure

The Setup and Configure screen allows the user to change the meter’s operating parameters

To access the Set Up and Configure screen, left-click Setup on the right sidebar on the Device Summary Screen.

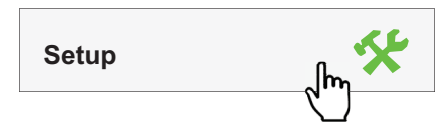

In the Setup and Configure screen the user can edit the General Configuration (section 6.5.1), Faults and Warnings (section 6.5.2), Relay Output (section 6.5.3), Frequency Output (section 6.5.4), 4-20 mA Output (section 6.5.5), and Pulse Output (section 6.5.6) settings by left-clicking the corresponding tab.

**IMPORTANT:** In order for any edits to take effect the user must Save (page 13, section 6.5.7) by left-clicking the Save button on the right sidebar on the Setup and Configure Screen. The user may also Cancel any changes by left-clicking Cancel.

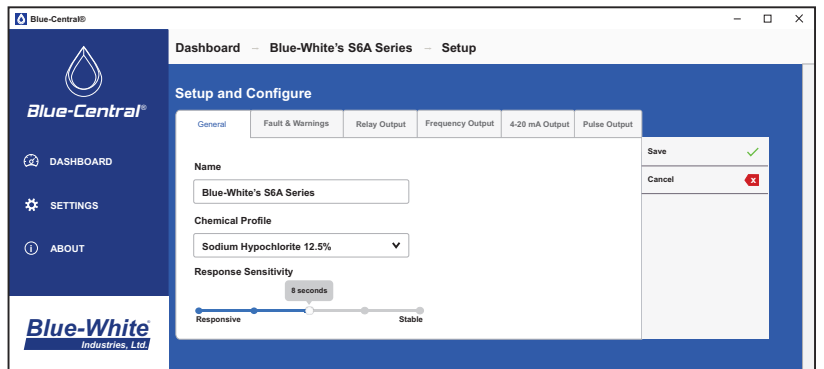

Setup and Configure



### 6.5.1 General

To edit the General Configuration left-click the General tab on the Setup and Configure screen.

**Name:** Edit the Name of the S6A meter by clicking in the Name field.

This will help to quickly identify which meter is being configured in Blue-Central®.

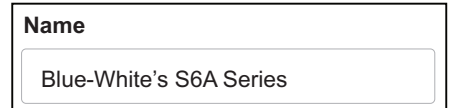

A screenshot of a text input field labeled "Name" containing the text "Blue-White's S6A Series".

**Chemical Profile:** Edit the Chemical Profile by left-clicking the drop-down menu.

This selectable field is used to determine which pre-calibrated chemical will be used with the meter. The correct pre-calibrated chemical must be selected for the meter to operate properly. Factory Default: Water

**Note:** If the chemical is not on the list, a Custom Chemical Calibration must be performed (page 17, section 9.1).

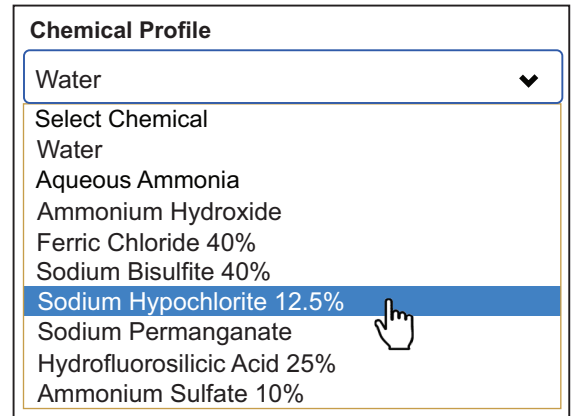

A screenshot of a dropdown menu titled "Chemical Profile". The current selection is "Water". The list of options includes: "Water", "Aqueous Ammonia", "Ammonium Hydroxide", "Ferric Chloride 40%", "Sodium Bisulfite 40%", "Sodium Hypochlorite 12.5%", "Sodium Permanganate", "Hydrofluorosilicic Acid 25%", and "Ammonium Sulfate 10%". A mouse cursor is pointing at "Sodium Hypochlorite 12.5%".

**Response Sensitivity:** Edit the Response Sensitivity of the S6A meter by clicking and dragging the slider to the right or left.

This selected value will change how many readings will be used to calculate flow-rate. A more Stable sensitivity will have a steadier reading but slower response time to changes in the flow-rate. A more Responsive sensitivity will have a faster response time with a less steady flow rate reading. Select from 1, 4, 8, 16, and 32 seconds. Factory Default: 8 seconds

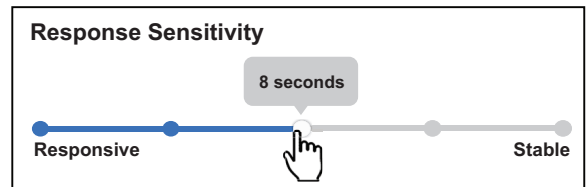

A screenshot of a slider control titled "Response Sensitivity". The slider ranges from "Responsive" on the left to "Stable" on the right. A hand icon is shown dragging the slider to a position labeled "8 seconds".

**IMPORTANT:** In order for any edits to take effect the user must Save (page 13, section 6.5.7) by left-clicking the Save button on the right sidebar on the Setup and Configure Screen. The user may also Cancel any changes by left-clicking Cancel.

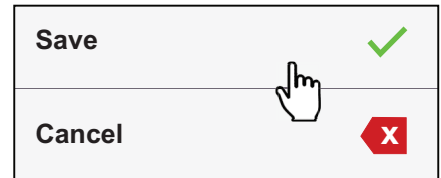

A screenshot of two buttons: "Save" with a green checkmark icon and "Cancel" with a red X icon. A mouse cursor is pointing at the "Save" button.

### 6.5.2 Faults and Warnings

To edit the Faults and Warnings settings the user must left-click the Faults and Warnings tab on the Setup and Configure screen.

In the Faults and Warnings screen the user can configure how the meter will respond to various Error Conditions by left-clicking in the appropriate drop-down menu and selecting between Continue Operation or Halt Operation.

**Continue Operation:** The meter will continue to operate normally. The Condition will clear if issue resolves. Note that the meter's accuracy may be compromised during an Error Condition (Bubbles, Poor/Low Signal) and its status will continue to display the Warning.

**Halt Operation:** Stops totalizer, disables Frequency Output, disables 4-20 mA output. The condition can be cleared by power cycling meter.

The Error Conditions are as follows:

**Bubbles (W2):** Bubbles in system leading to inaccurate readings.

**Poor/Low Signal (W3):** Low signal leading to inaccurate readings.

**Empty Tube (W4):** meter is unable to obtain a reading due to an empty meter body.

**System Failure (F1):** Hardware failure.

**IMPORTANT:** In order for any edits to take effect the user must Save (page 13, section 6.5.7) by left-clicking the Save button on the right sidebar on the Setup and Configure Screen. The user may also Cancel any changes by left-clicking Cancel.

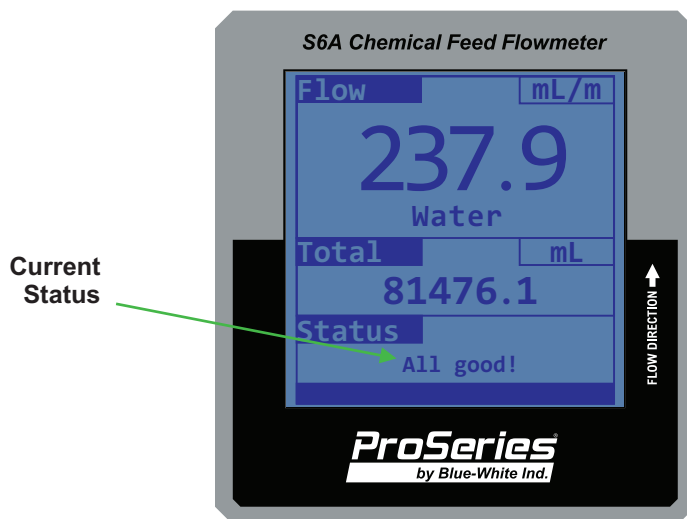
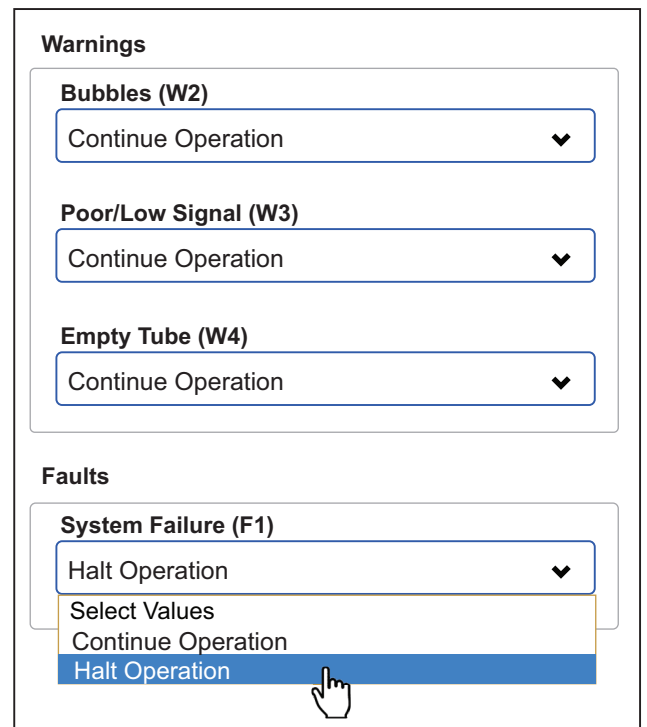

Meter Mount Display Model

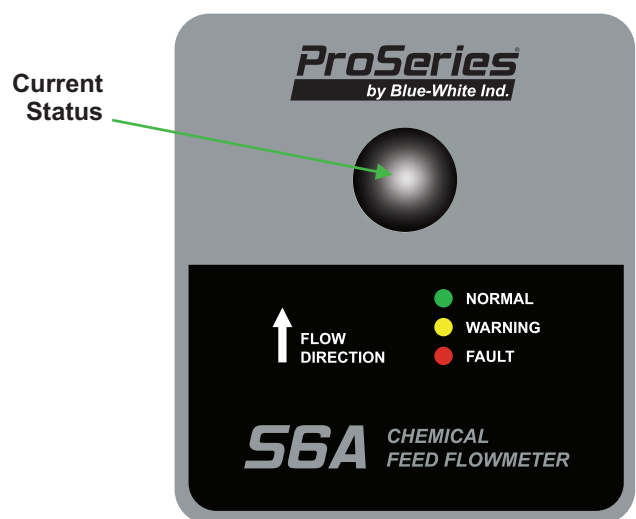

Remote Mount Display Model

### 6.5.3 Relay Output

To edit the Relay Output settings the user must left-click the Relay Output tab on the Setup and Configure screen. Here the user can select the Operation Mode (Flow Rate or Totalizer) and Switch Operation (if the relay will open or close when triggered).

#### Totalizer Mode

During operation in this mode when the specified Trigger Volume is reached the relay will either open or close depending on the setting for Switch Operation and stay in this position for the unit of time set in Trigger Duration.

**Trigger Volume:** Each time the meter detects a specified volume of flow it will trigger the relay. Edit the Trigger Volume by left-clicking in the Trigger Volume field. Factory Default: 40 mL

**Trigger Duration:** This value determines how long the switch will be activated. Edit the Trigger Duration by left-clicking the Trigger Duration drop-down menu. Factory Default: 10 seconds. Range: 1 to 10 seconds

The screenshot shows the 'Relay Output' configuration interface. At the top, 'Operation Mode' has two radio buttons: 'Totalizer' (selected) and 'Flow Rate'. Below this, 'Switch Operation' is a dropdown menu set to 'OPEN ON TRIGGER'. The 'Totalizer Mode' section contains two more dropdown menus: 'Trigger Volume in mL (mL)' set to '5000' and 'Trigger Duration in Seconds' set to '10 Seconds'.

#### Flow Rate Mode

During operation in this mode the user can select a Low Set Point, a High Set Point, a Low Set Point Hysteresis, and High Set Point Hysteresis.

**Flow Rate - Low Set Point:** Activate a Low Set Point by clicking the Yes radio button. Edit the Low Set Point by left-clicking in the Low Set Point field and changing the value to the desired Flow Rate. The relay will activate once the specified flow rate has been reached. Factory Default: 100 mL/min

**Low Set Point Hysteresis:** Edit the Low Set Point Hysteresis by left-clicking in the Low Set Point Hysteresis field. The system will trigger when the flow falls to (or below) the low set point and will only untrigger when the flow rises to (or above) the low set point + low set point hysteresis.

For example: If the low set point is set to 100 mL with 10 mL hysteresis, the relay will trigger when the flow falls to (or below) 100 mL and untrigger when the flow rises to (or above) 110 mL. Factory Default: 50 mL/min

**Flow Rate - High Set Point:** Activate a High Set Point by clicking the Yes radio button. Edit the High Set Point by left-clicking in the High Set Point field and changing the value to the desired Flow Rate. The relay will activate once the specified flow rate has been reached. Factory Default: 500 mL/min

**High Set Point Hysteresis:** Edit the High Set Point Hysteresis by left-clicking in the High Set Point Hysteresis field. The system will trigger when the flow rises to (or above) the high set point and will only untrigger when the flow falls to (or below) the high set point - high set point hysteresis.

For example: If the high set point is set to 1000 mL with 50 mL hysteresis, the relay will trigger when the flow rises to (or above) 1000 mL and untrigger when the flow falls to (or below) 950 mL. Factory Default: 50 mL/min

The screenshot shows the 'Relay Output' configuration interface in Flow Rate Mode. 'Operation Mode' has 'Flow Rate' selected. 'Switch Operation' is 'OPEN ON TRIGGER'. The 'Flow Rate - Low Set Point' section has 'Active' checked, 'Set Point at mL per minute (mL/m)' set to '100', and 'Hysteresis at mL per minute (mL/m)' set to '50'. The 'Flow Rate - High Set Point' section has 'Active' unchecked.

**IMPORTANT:** In order for any edits to take effect the user must Save (see page 13, section 6.5.7).

## 6.5.4 Frequency Output

To edit the Frequency Output settings the user must left-click the Frequency Output tab on the Setup and Configure screen.

These selectable fields are used to send a high speed frequency signal to an external device such as a ProSeries pump.

**Flow Rate Range:** Edit the Flow Rate Minimum by left-clicking in the field on the left and the Flow Rate Maximum by left-clicking in the field on the right. Factory Default: 0 mL/m minimum and 5000 mL/m maximum

These selectable fields are used to determine at which Flow Rate the meter should respond and provide an output.

**Frequency Output Range in Hz:** Edit the Minimum Hz by left-clicking in the field on the left and the Maximum Hz by left-clicking in the field on the right. Factory Default: 0 Min Hz minimum and 1000 Hz maximum (when ordered with a S6A Display, the default is 400 Hz)

These selectable fields are used to determine at which range the Flow Rate should be scaled to the Frequency Output.

**IMPORTANT:** In order for any edits to take effect the user must Save (see page 13, section 6.5.7).

## 6.5.5 4-20 mA Out

To edit the 4-20 mA Out settings the user must left-click the Out 4-20 mA tab on the Edit Configuration screen.

These selectable fields are used to send a 4-20 mA signal to an external device such as a ProSeries pump.

**Flow Rate Range (mL/m):** Edit the Flow Rate Min by left-clicking in the field on the left and the Flow Rate Max by left-clicking in the field on the right. Factory Default: 0 mL/m minimum and 5000 mL/m maximum

These selectable fields are used to determine at which Flow Rate the meter should respond and provide an output.

**Note:** 4-20 Output range is currently not editable.

**IMPORTANT:** In order for any edits to take effect the user must Save (see page 13, section 6.5.7).

<b>Flow Rate Range in (mL/m)</b>	
0	5000
<b>Frequency Output Range in Hz</b>	
0	1000

<b>Flow Rate Range in (mL/m)</b>	
0	5000
<b>4-20 Output Range in mA</b>	
4	20

### 6.5.6 Pulse Out

To edit the Pulse Out settings the user must left-click the Pulse Output tab on the Setup and Configure screen.

These selectable fields are used to send a pulse signal for a specified duration (Pulse width) to an external device such as a ProSeries pump for any specified volume (Volume per Pulse). For example, the user can send a pulse signal to activate a pump to start dosing a system when a certain volume has been reached.

**Volume per Pulse:** Edit Volume per Pulse by left-clicking in the Volume per Pulse field. Factory Default: 50 mL

**Pulse width(ms):** Edit Pulse width (ms) by left-clicking the drop-down menu. Select from 64, 128, 256, 384, 512, 640, 768, 896, and 1024 milliseconds. Factory Default: 128 ms

**IMPORTANT:** In order for any edits to take effect the user must Save (see section 6.5.7 below).

The screenshot shows two input fields within a bordered box. The first field is labeled "Volume per Pulse (mL)" and contains the value "50". The second field is labeled "Pulse Duration (milliseconds)" and contains the value "128". Both fields have a small downward arrow icon on the right side, indicating they are dropdown menus.

### 6.5.7 Saving

When the configuration is complete, left click Save on the right sidebar. A Device Configuration Status dialog box will appear to notify the user that a save is in progress and to not disconnect the device during this time. Once the configuration has been saved successfully left-click Close.

**Note:** When saving, the meter will turn off momentarily.

To cancel any changes made, select Cancel. This will take the user back to the Details screen

The screenshot shows two buttons: "Save" and "Cancel". The "Save" button is on the left and has a green checkmark icon on the right. The "Cancel" button is on the right and has a red X icon on the right. A hand cursor is pointing at the "Save" button.

The screenshot shows a dialog box with a blue header "Device Configuration". The main content area contains the text "Saving configuration..." and "Please DO NOT disconnect the device!". Below the text is a blue circular progress indicator.

The screenshot shows a dialog box with a blue header "Device Configuration". The main content area contains the text "Configuration saved successfully." and a blue button labeled "Close". A hand cursor is pointing at the "Close" button.

**Note:** Exiting the Setup and Configure screen without saving after modifications have been made will prompt the user to then Save or Discard any changes.

The screenshot shows a dialog box with a blue header "Device Configuration". The main content area contains the text "Modified configuration has not been applied yet. Would you like to apply changes?". Below the text are two buttons: a blue "Save" button and a yellow "Discard" button. A hand cursor is pointing at the "Save" button.

## 7.0 Upgrade Firmware

To download and install the latest firmware left-click Upgrade Firmware on the right sidebar of the Device Summary Screen.



The user will be taken to the Latest Firmware screen. Left-click Start Upgrade on the right sidebar to download and install the latest firmware. Upgrading the firmware will ensure that the meter has the most up-to-date software.

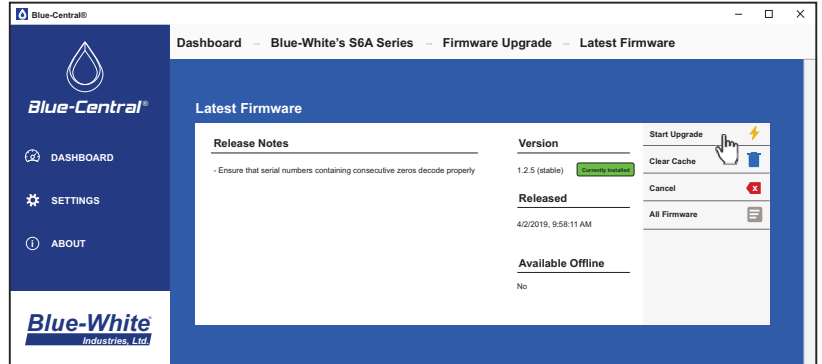

Latest Firmware

Upon clicking Start Upgrade a Firmware Upgrade dialog box will appear notifying the user that the upgrade is in progress.

**Note:** Maximum download time is two minutes.

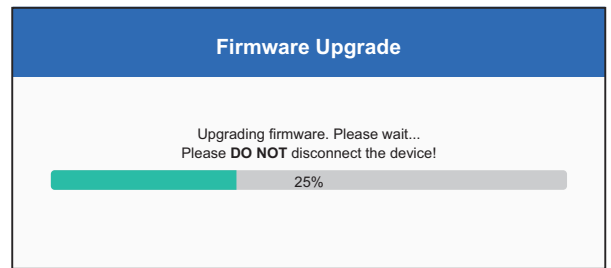

Once the firmware has been successfully upgraded, left-click the close button.

**Note:** If the firmware fails to upgrade, left-click Clear Cache on the right sidebar and try again.

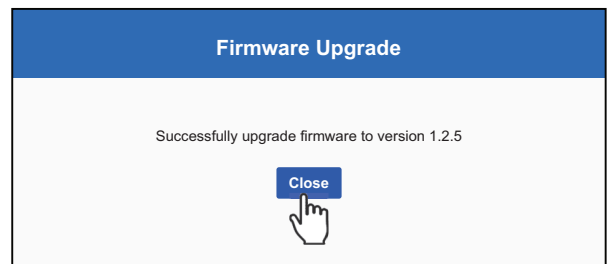

**Note:** If a new firmware version is available, a button will appear in the Firmware Version section of the Device Summary screen. Left-clicking the button will download and install the latest firmware

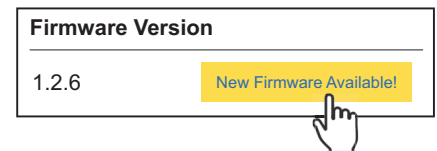

## 8.0 Factory Reset

To restore the meter to the factory default settings and firmware the user must perform a Factory Reset. To do so, on the Device Summary screen, left-click Factory Reset located on the right sidebar.



The Factory Reset dialog box will appear. Note that a Factory Reset will reset the device's configuration to default as well as clear all totalizer values from the device's memory.

Click OK to proceed the Factory Reset or click Close to cancel.

**Note:** If a Digital Drawdown (section 9.0) has been performed a factory reset will revert the meter back to its original operating mode.



## 9.0 Digital Drawdown

Digital Drawdown allows the user to increase the accuracy of the meter at a targeted feed rate. To access the Digital Drawdown screen, left-click Digital Drawdown on right sidebar of the Device Summary screen.

Digital Drawdown



**Note:** This is an optional feature and not required for the meter to function properly.

### Steps to Digital Drawdown:

- Step 1:** Select the desired Chemical Profile (see page 9, section 6.5.1). If the desired chemical isn't listed, a Custom Chemical Calibration must be performed (see page 17, section 9.1)
- Step 2:** Establish Known Flowrate of the system by performing a draw down test. To do this, the meter must be properly installed in the system and connected to a desktop or laptop computer.
- Step 3:** Enter Known Flowrate into the Known Flowrate field on the Digital Drawdown screen.
- Step 4:** Ensure the system is running at the same speed as when the draw down test was performed and that there are no bubbles in the fluid line and left click the Start button on the Digital Drawdown screen. The Digital Drawdown process will take about 1 to 2 minutes.

**Note:** To revert the meter back to its original operating mode, the user must perform a Factory Reset.

**Chemical Profile**

Blue-Central

DASHBOARD  
SETTINGS  
ABOUT

Dashboard → Blue-White Chemical Feed Sensor (S6A) → Digital Drawdown

### Digital Drawdown for Sodium Hypochlorite 12.5%

**Details:**  
Calibrating sensor to your targeted flow rate increases accuracy within a narrowed flow range. Graph below illustrates estimated accuracies after calibration.

**Steps:**

- Using a calibration column, perform a draw down to determine actual pump output. Note: other flow measurement devices can be used to determine pump output, example: scales, turbines, etc.
- Once you have confirmed pump output. Type in your flow rate in **Known Flowrate** textbox
- Start (run) your pump at exact same speed as measured above (step 1).
- With pump running, click **Start** button. The sensor will calibrate itself by running a series of automated tests. Allow your pump to run at same speed during entire calibration period. Testing may last up to 2 minutes.

**Note:** You should always verify accuracy in your own system after performing a Digital Drawdown.

Estimated Accuracy:  
At mL/m  
Error % (+/- mL/m)

Known Flowrate  mL/m **Start**

### Known Flowrate field

Estimated Error per mL/m

Known Flowrate (mL/m)	Estimated Error (%)
0.3	15%
0.4	12%
0.5	10%
0.6	8%
0.7	6%
0.8	4%
0.9	2%
1.0	0%
1.1	1%
1.2	2%
1.3	3%
1.4	4%
1.5	5%
1.6	6%
1.7	7%

Blue-White Industries, Ltd.



## 9.1 Customize Chemical Calibration

Custom Chemical Calibration can be used to configure the S6A meter to a chemical that is not listed among the Pre-Calibrated Chemical Profiles (see page 3, section 2.0).

### CAUTION

- Chemicals must conduct ultrasonic sound to be measured.
- Chemicals must be relatively clean. Particles can affect accuracy. It is recommended to use a strainer before meter to prevent particles from entering the meter.

### Steps to Custom Chemical Calibration:

**Step 1:** In the Device Summary screen left click Setup on the right sidebar.

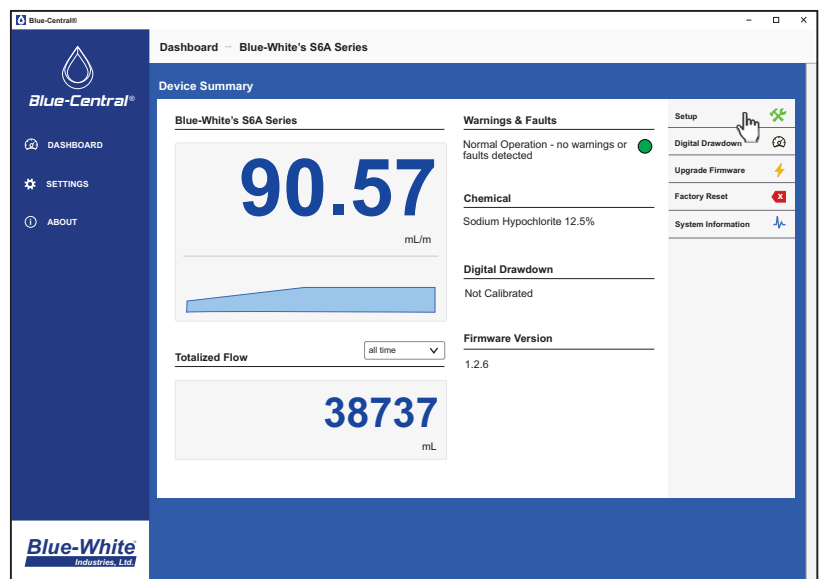

**Step 2:** Select Water under the Chemical Profile drop down list.

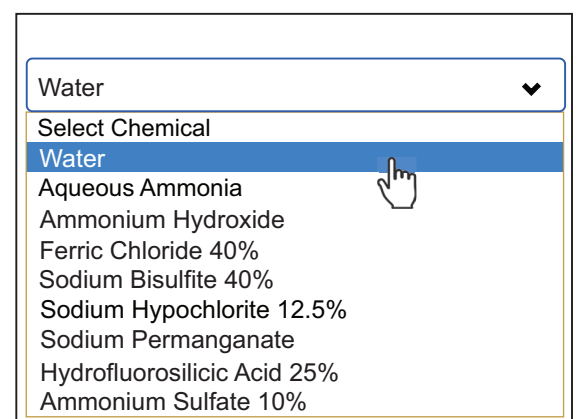

**Step 3:** Select Digital Drawdown.

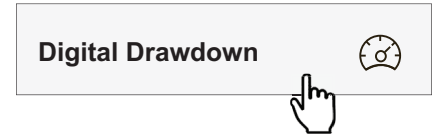

**Step 4:** With the meter properly installed in the system and connected to a desktop or laptop computer, the user must establish Known Flowrate of the system by performing a draw down test.

**Step 5:** Enter Known Flowrate into the Known Flowrate field on the Digital Drawdown screen.

**Step 6:** Ensure the system is running at the same speed as when the draw down test was performed and that there are no bubbles in the fluid line and left click the Start button on the Digital Drawdown screen. The Digital Drawdown process will take about 1 to 2 minutes. The S6A will now be calibrated to the custom chemical being used.

Chemical Profile

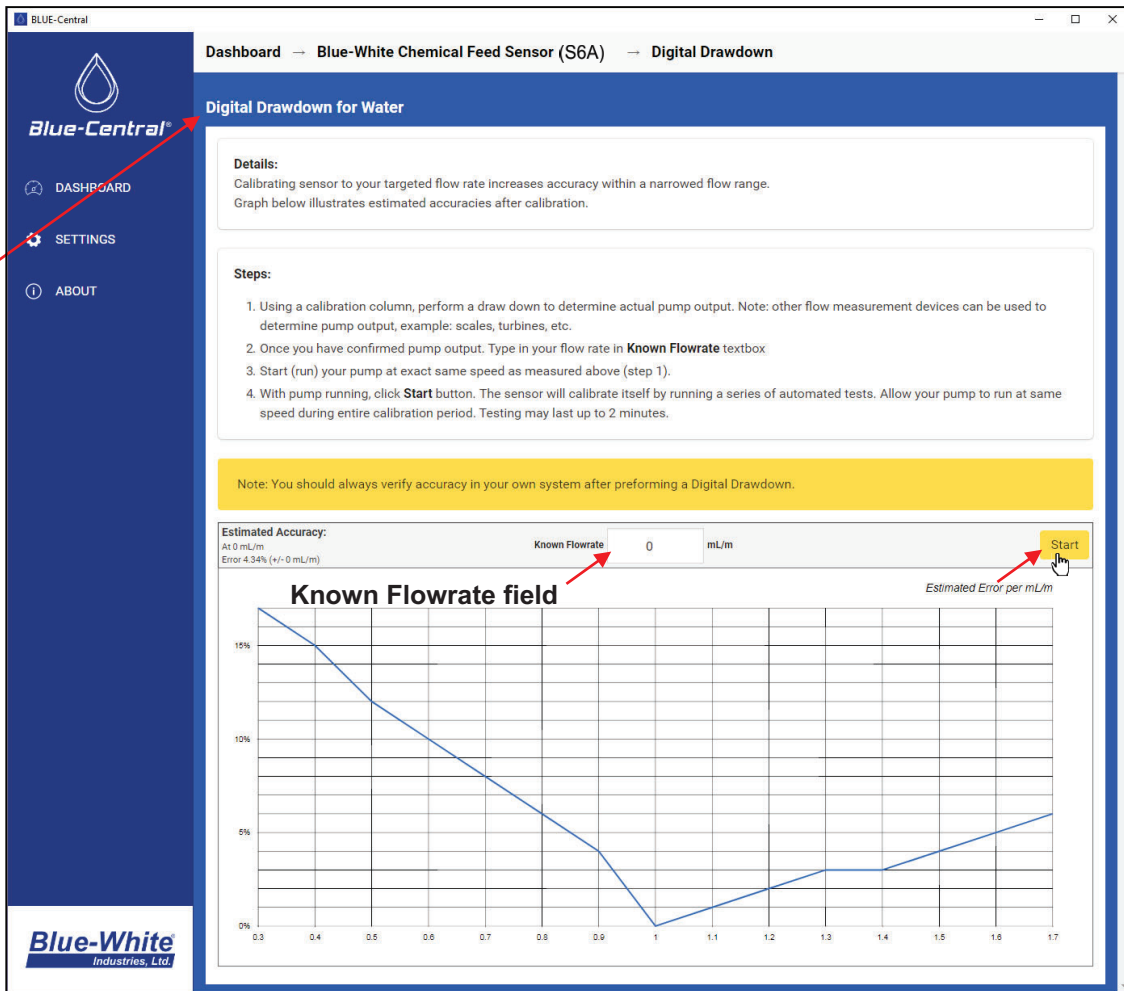

**Estimated Accuracy:**  
At 0 mL/m  
Error 4.34% (+/- 0 mL/m)

Known Flowrate: 0 mL/m

Start

### Known Flowrate field

Estimated Error per mL/m

Flowrate (mL/m)	Estimated Error (%)
0.3	15%
0.4	12%
0.5	10%
0.6	8%
0.7	6%
0.8	4%
0.9	2%
1.0	0%
1.1	1%
1.2	2%
1.3	3%
1.4	4%
1.5	5%
1.6	6%
1.7	7%

Digital Drawdown

**Step 7:** Navigate to the System Information screen to verify the Custom Chemical Calibration was successful

**Step 8:** Check if all the Error lights are off under the Errors & Warnings Settings section of the System Information screen. If one of the error lights are active then the calibration was unsuccessful. The fluid either does not conduct sound, has too many particles, or air bubbles were present during calibration.

**Step 9:** Check the real time flow rate under the Flow Rate section of the System Information screen. It will be the value entered in the Known Flowrate in step 5. The S6A is now calibrated to the custom chemical.

**Note:** If the known flow rate does not match it is recommended to repeat the custom set point process.

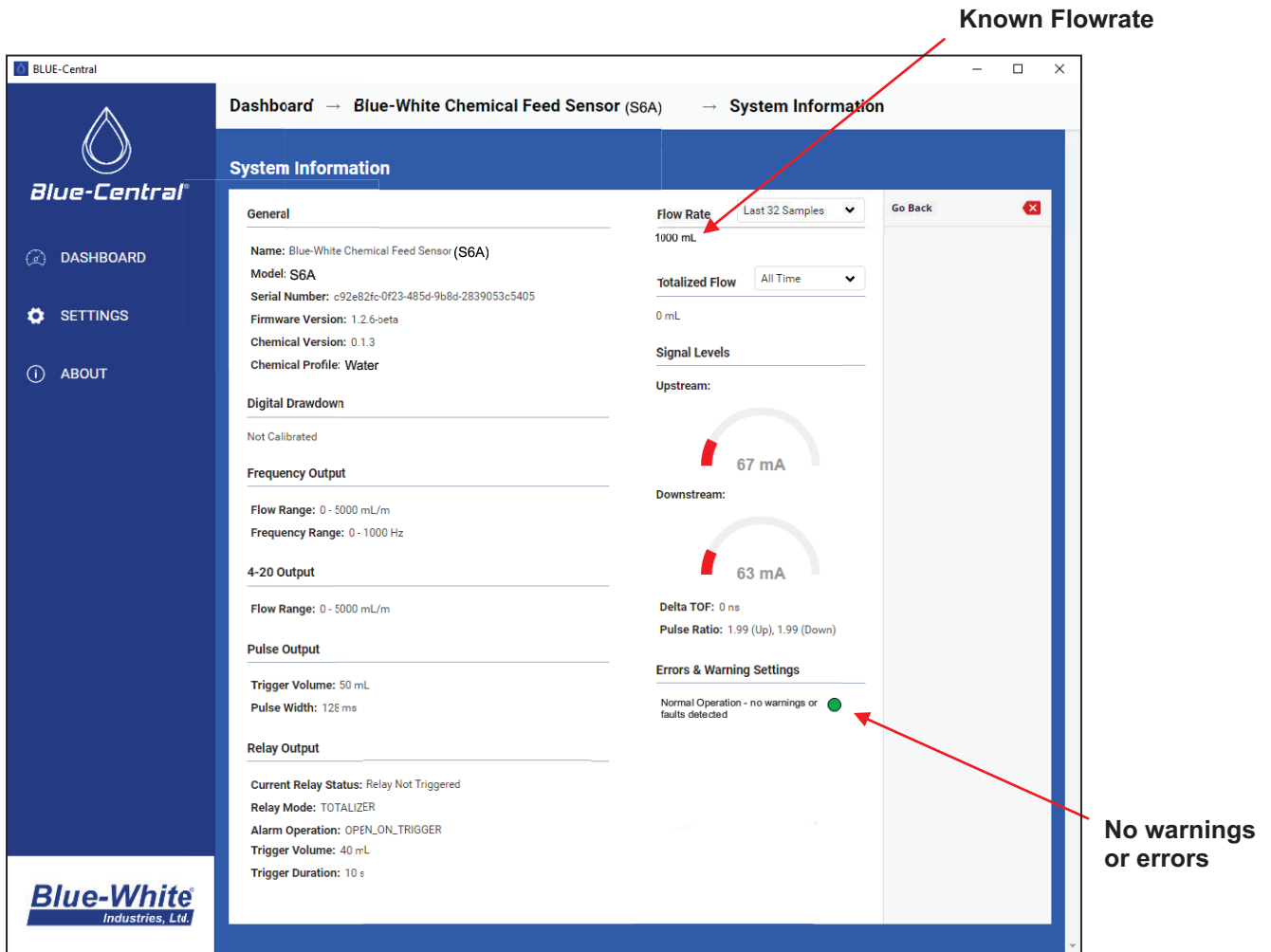

System Information

## 10.0 System Information

To enter the System Information screen, click System Information on the ride sidebar of the Device Summary screen.

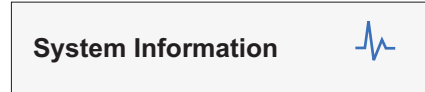

In the System Information screen the user can view General information, Digital Drawdown status, Frequency Output settings, 4-20 Output settings, Pulse Output settings, Relay Output settings, Flow Rate, Totalized Flow, Signal Levels (for advanced users and technical support), and Error & Warning Settings.

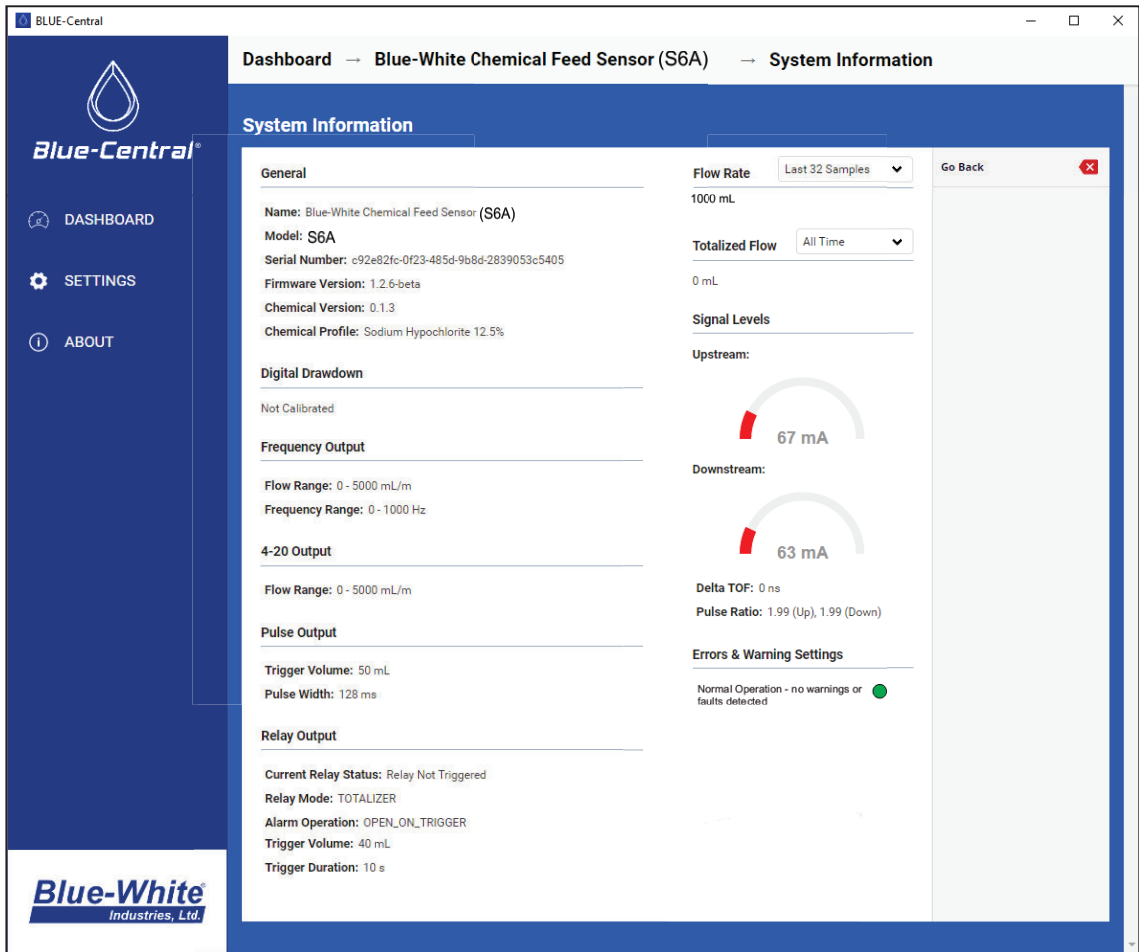

System Information

## 11.0 Wiring Installation

The meter must be powered by 5 volts DC. Wattage must not exceed 5 watts.

20-24 AWG (American wire gauge) shielded cable is recommended for signal output connections.

### 11.1 Cable Gland Liquid-Tight Connections

The S6A wiring compartment is equipped with:

- Two communications cable liquid-tight cable gland grommets for cable diameters from .190 to .205 inches.

**Note:** The blank grommet plug should be used when the communications cable grommet is not required.

### 11.2 Wiring Terminal

To access the wiring terminal, open the enclosure by removing the four screws with the provided 3/16" hex key.

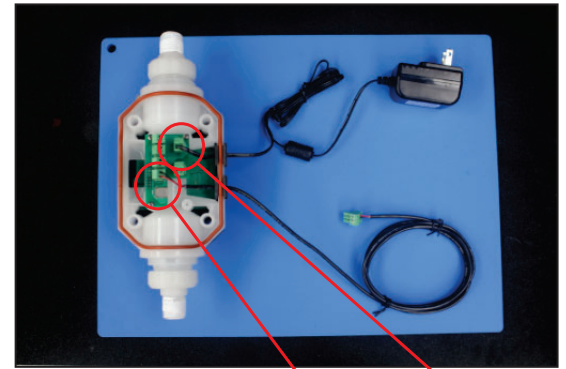

In this example the user has wired both Power and 4-20mA Out.

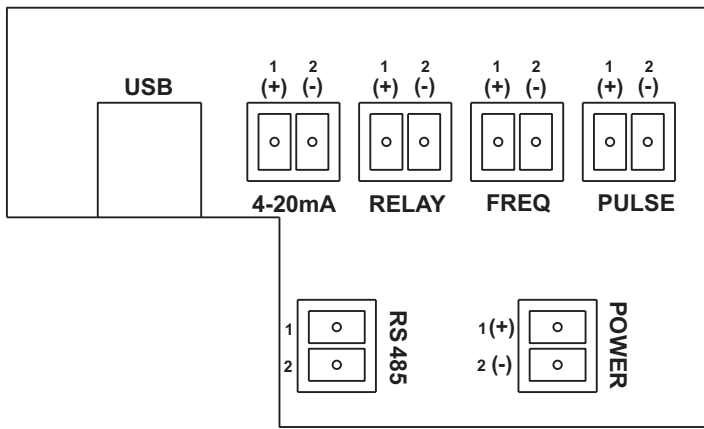
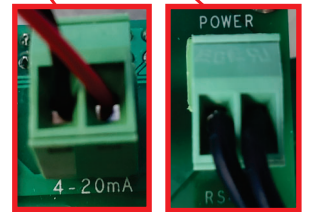

Meter Wiring Terminal

FUNCTION	TERMINAL	PIN #	RATING	ELECTRICAL SP.	BLOCK DIAGRAM
INPUT: POWER		1	DC POSITIVE (+)	5VDC 5 WATTS MAX	
		2	DC GROUND (-)		
OUTPUT: 4-20 mA		1	(+) POSITIVE	120 OHM RESISTANCE ACTIVE LOOP	
		2	(-) NEGATIVE		
OUTPUT: FREQUENCY - OPEN COLLECTOR		1	SIGNAL		
		2	GROUND		
OUTPUT: FVS SYSTEM - OPEN COLLECTOR		1	(+) POSITIVE		
		2	GROUND		
OUTPUT: RELAY (SOLID STATE)		1	(+) POSITIVE	MAX V = 48V MAX A = 80mA	
		2	(-) GROUND		
OUTPUT: PULSE - OPEN COLLECTOR		1	(+) POSITIVE		
		2	(-) GROUND		
OUTPUT: RS-485		1	Rx	NOT ACTIVE	
		2	Tx		

### 11.3 FVS Wiring Guide - S6A to ProSeries Pump

The following section is a step-by-step guide on wiring an S6A Chemical Feed Flowmeter to a ProSeries metering pump as a Flow Verification Sensor (FVS).

What you'll need:

- 16-24 AWG shielded cable
- 4.7k Ohms resistor

**Note:** Voltage is supplied by the ProSeries pump (PIN 1 of the T4 terminal)

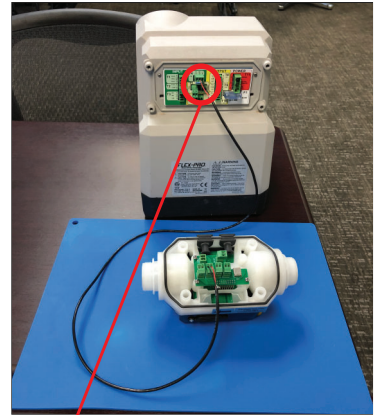

**Step 1.** Connect 4.7k Ohms resistor from PIN 1 to PIN 2 of the terminal marked T4 on the ProSeries pump wiring terminal.

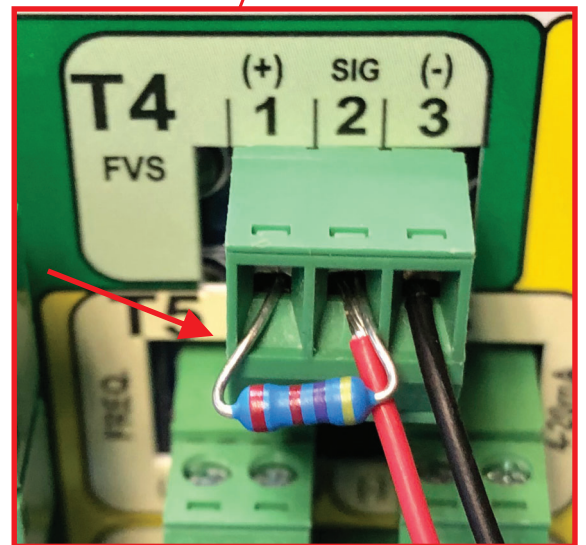

**Step 2.** Trim the bare and connect the RED WIRE to PIN 2 (SIG) and the BLACK WIRE to PIN 3 of the terminal marked T4

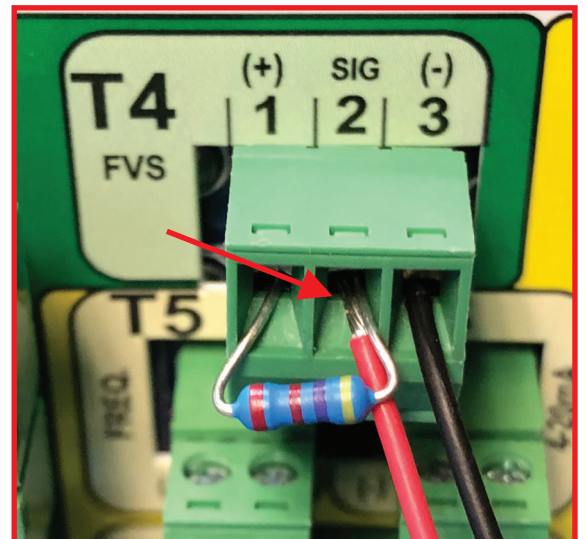

**Step 3.** Trim the bare and connect the RED WIRE to the left positive PIN 1 and the BLACK WIRE to the right negative PIN 2 on the FREQUENCY terminal on the S6A circuit board.

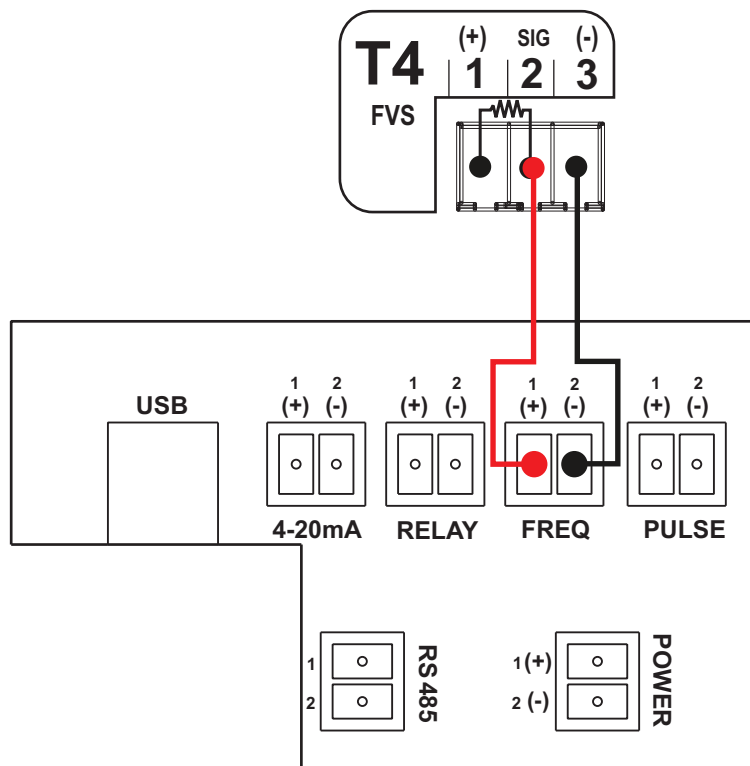

S6A Meter Board

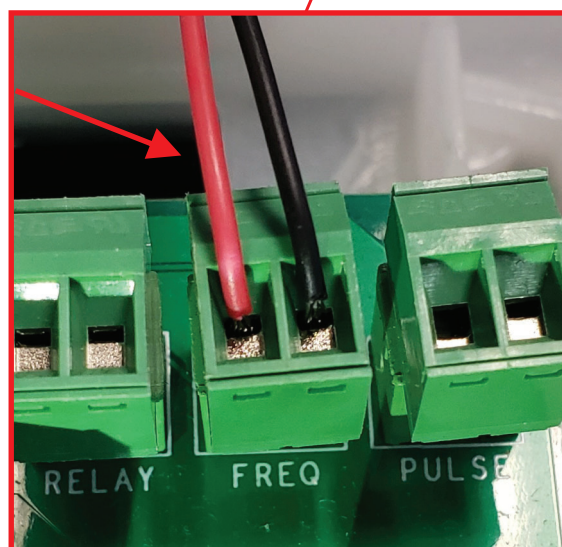

## 12.0 S6A Remote Mount Display

The S6A Remote Mount Display includes a power supply and is pre-wired at the factory.

### 12.1 Display Terminal Configuration

	Terminal	Function
<b>POWER 5VDC 5 WATTS MAX</b>	6	Positive (+) power input (black with stripe wire from 5VDC plug-in transformer and red wire to S6A meter)
	5	Ground (-) power input (black wire from 5VDC plug-in transformer and black wire to S6A meter)
<b>S6A meter INPUT</b>	2	Ground (-) input (FREQ PIN 2 on meter circuit board - black wire from meter body)
	3	Pulse (+) input (FREQ PIN 1 on meter circuit board - yellow or red wire from meter body)

Jumpers	Function
J1 Installed	Battery Input - <b>NOT USED FOR S6A APPLICATIONS</b>
J1 Left Open	5VDC <b>REQUIRED FOR S6A APPLICATIONS</b>
J2 Installed	Front Panel Programming is Disabled
J2 Left Open	Front Panel Programming is Enabled (factory default)
J3 Installed and J4 Left Open	S6A meter input - <b>REQUIRED FOR S6A APPLICATIONS</b>
J3 Left Open and J4 Installed	AC Coil meter Input - <b>NOT USED FOR S6A APPLICATIONS</b>

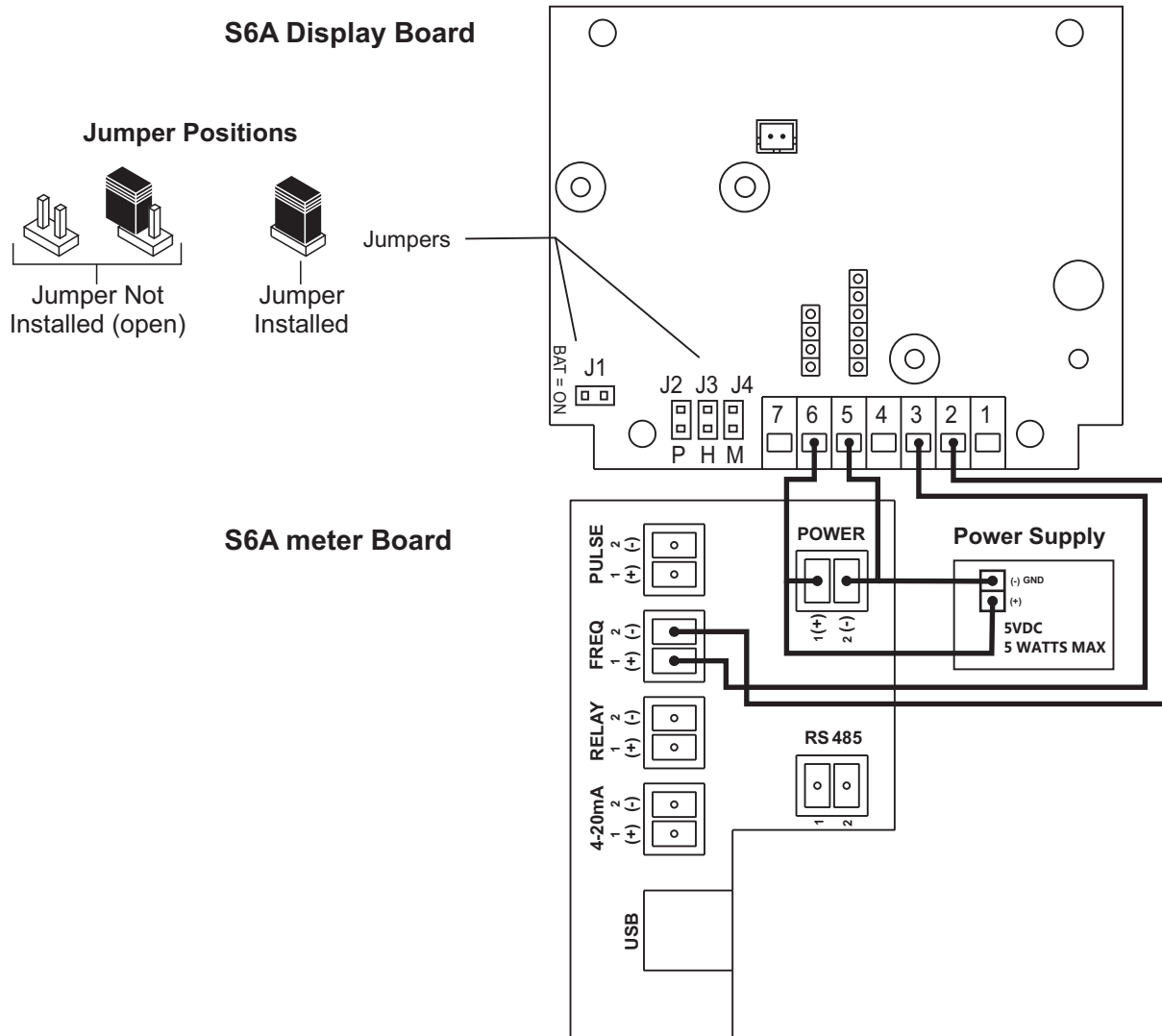



## 12.2 Wiring S6A Remote Mount Display to S6A meter Body

### Connecting Frequency Output

Connect the frequency cable RED OR YELLOW WIRE to pin 1 and the BLACK WIRE to PIN 2 of the terminal marked FREQ on the S6A meter circuit board.

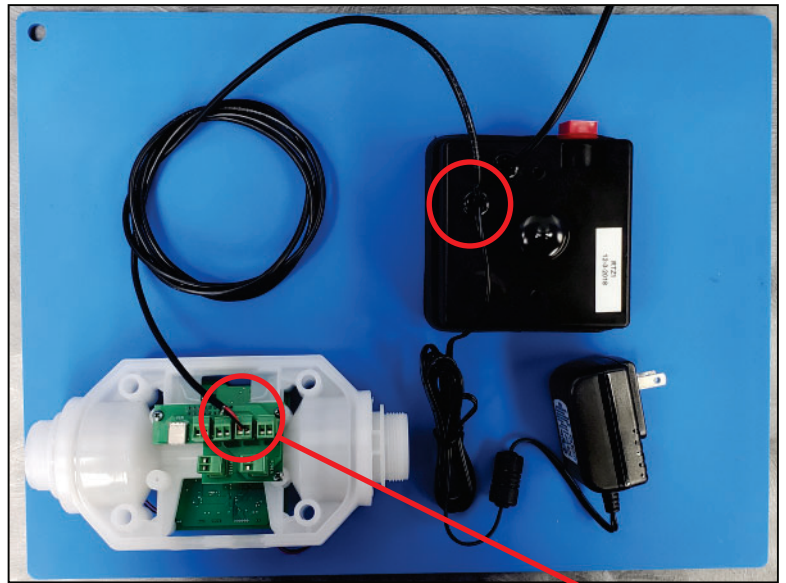
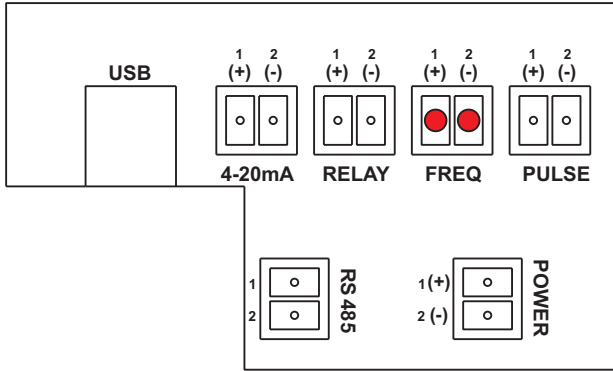

### Connecting Power

Connect the power cable RED WIRE to pin 1 and the BLACK WIRE to PIN 2 of the terminal marked POWER on the S6A meter circuit board.

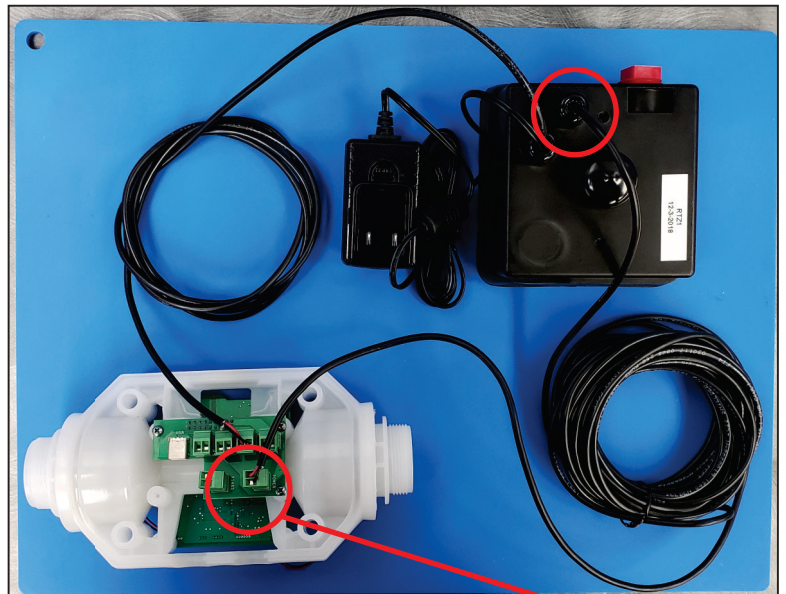
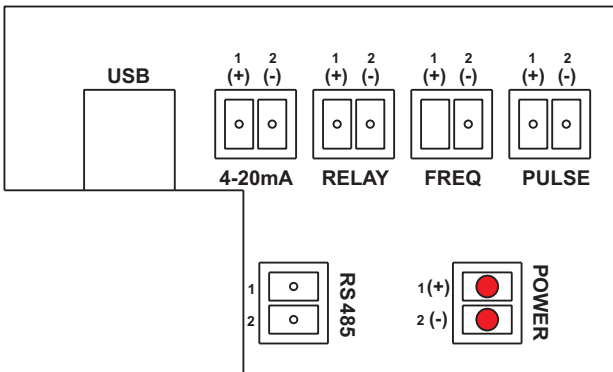

## 13.0 Programming the Remote Mount S6A Display

The S6A Display will use the FREQUENCY (Hz) output signal from the S6A meter to calculate and display flow. Once the FREQUENCY output signal parameters are configured in the S6A meter, the S6A display rate scale factor and total scale factors can then be calculated and programmed into the S6A Display.

### 13.1 S6A Meter Frequency Output Signal Configuration

Configure the minimum and maximum Hz output signal to correspond with minimum and maximum flow-rate display.

To edit the Frequency Output settings the user must left-click the Frequency Output tab on the Setup and Configure screen.

These selectable fields are used to send a high speed frequency signal to an external device such as a ProSeries pump.

**Flow Rate Range:** Edit the Flow Rate Minimum by left-clicking in the field on the left and the Flow Rate Maximum by left-clicking in the field on the right. Factory Default: 0 mL/m minimum and 5000 mL/m maximum

These selectable fields are used to determine at which Flow Rate the meter should respond and provide an output.

**Frequency Output Range in Hz:** Edit the Minimum Hz by left-clicking in the field on the left and the Maximum Hz by left-clicking in the field on the right. Factory Default: 0 Min Hz minimum and 1000 Hz maximum (when ordered with a S6A Display, the default is 400 Hz)

These selectable fields are used to determine at which range the Flow Rate should be scaled to the Frequency Output.

**Note:** The units of measure shown will be the same units displayed on the S6A Remote Mount Display. To change the volume units of measure, see **section 6.2 Settings**.

**IMPORTANT:** In order for any edits to take effect the user must Save (see page 13, section 6.5.7).

**Flow Rate Range in (mL/m)**

0  to 5000

**Frequency Output Range in Hz**

0  to 1000

### 13.2 S6A Remote Mount Display Configuration

The following S6A programming screens are used to input the calibration constants.

Screen No.	Programming Functions
RATE 1	Input flow Rate Scale Factor - ( $S_r$ )
RATE 2	Input flow rate display Decimal Point Factory - ( $D_r$ )
RATE 3	Not Used
TOTAL 1	Input flow Total Scale Factor - ( $S_t$ )
TOTAL 2	Input total flow display Decimal Point Factor - ( $D_t$ )
TOTAL 3	Toggle front panel Clear Total button - on (enabled) / off (disabled) -- (factory default: off)

### 13.2.1 S6A Suggested Default Display Calibration Constants

The following default S6A Remote Mount Display calibration constants should be used for most applications in ml/min, GPH or LPH. These values must be programmed into the display unit.

Screen No.	Model Number S6A11			Model Number S6A21		
	ml/min	GPH	LPH	ml/min	GPH	LPH
RATE 1	0124.38	019.711	074.625	0248.75	03.9422	014.925
RATE 2	0000.0	000.00	000.00	0000.0	000.00	000.00
RATE 3	Not Used	Not Used	Not Used	Not Used	Not Used	Not Used
TOTAL 1	02.0729	00.0055	00.0207	04.1458	00.0657	00.2488
TOTAL 2	0000.0	000.00	000.00	0000.0	000.00	000.00
TOTAL 3	ON	ON	ON	ON	ON	ON

Use the following data to calculate custom Display Calibration Values only if using units of measure other than the above, or if your desired displayed decimal point location is other than above.

### 13.2.2 Determine the Decimal Rate Factor (D<sub>r</sub>)

Desired Flow Rate Decimal Location = D<sub>r</sub> (Decimal Rate Factor) *Note: Four decimal places maximum.*

- 00000 = 1
- 0000.0 = 10
- 000.00 = 100
- 00.000 = 1000
- 0.0000 = 10000

### 13.2.3 Calculate the Rate Scale Factor

The flow rate scale factor is determined by the S6A meter Frequency Out. The equation used is as follows:

$$S_r = \frac{D_r \times \text{Max Flow-rate} \times .995}{\text{Max Hz}}$$

**Example:**

Max Flow-rate = 2000  
 Max Hz = 400  
 D<sub>r</sub> = 10

$$S_r = \frac{10 \times 2000 \times .995}{400}$$

$$S_r = \frac{19900}{400}$$

$$S_r = 49.75$$

**Flow Rate Range in (mL/m)**

0  to 5000

**Frequency Output Range in Hz**

0  to 1000

### 13.2.4 Determine the Decimal Total Factor

**Desired Location = D<sub>t</sub> (Decimal Total Factor)** **Note:** Four decimal places maximum.

- 00000 = 1
- 0000.0 = 10
- 000.00 = 100
- 00.000 = 1000
- 0.0000 = 10000

### 13.2.5 Determine the Time Factor

**Time Factor = t<sub>t</sub>**

- Example: Per Minute = 60 seconds
- Per Hour = 3600 seconds
- Per Day = 86400 seconds

### 13.2.6 Calculate the Total Scale Factor

The total scale factor is determined by the configuration inputted into Blue-Central<sup>®</sup> for the Frequency Output. The equation used is as follows:

$$S_r = \frac{D_t \times \text{Max Flow-rate} \times .995}{\text{Max Hz} \times t_t}$$

**Example:**

Max Flow-rate = 2000	$S_t = \frac{100 \times 2000 \times .995}{400 \times 60}$
Max Hz = 400	
D <sub>t</sub> = 100	
t <sub>t</sub> = 60	
	$S_t = \frac{199000}{400 \times 60}$
	$S_t = 8.29$

**Flow Rate Range in (mL/m)**

0  to 5000

**Frequency Output Range in Hz**

0  to 1000





### 14.0 Programming the S6A Remote Mount Display (step by step guide)

**Note:** While in the programming mode, if no buttons are pressed within twenty seconds, the programming mode is automatically exited without saving the input of the last screen.

(values for model S6A11 in GPH are shown in the illustrations below)





#### Step 1: Entering the Rate Scale Factor.

- Press and hold down  for at least 1.25 seconds.
- Enter the Rate Scale Factor calculated in section 13.2.3.
- Press  to select the digit to be modified or the decimal point. **Note:** The selected digit will blink to notify you it is selected. (note that the decimal point may be hidden to the right. Press  to move it)
- Press  to modify the selected digit or the decimal point. Repeat the process until all digits have been modified.
- When finished, press . This will move you to the RATE 2 screen.





#### Step 2: The Rate Decimal Point Location screen.

- Press  once to see the decimal point appear. Press  repeatedly until the decimal point is located in the desired location. Then press  twice to move you to Total 1.





#### Step 3: The Total Scale Factor screen is selected.

- Enter the Total Scale Factor calculated in section 13.2.6.
- Press  to select the digit to be modified or the decimal point. **Note:** The selected digit will blink to notify you it is selected.
- Press  to modify the selected digit or the decimal point. Repeat until all digits have been Entered.
- When finished, press . This will move you to the TOTAL 2 screen.



#### Step 4: The Total Decimal Point Location screen.

- Press  once to see the decimal point appear. Press  repeatedly until the decimal point is located in the desired location. Then press  twice to move you to Total 1.



## 15.0 Installation

The S6A Chemical Feed Flowmeter is designed to withstand outdoor conditions. A cool, dry location, where the unit can be easily monitored is recommended. Special ventilation is not required.

### 15.1 Mounting Location

For the S6A Chemical Feed Flowmeter to operate properly the pipe must be full, therefore it must be installed in a vertical position with fluid flowing in an upward direction.

To reduce large particles and bubbles that can reduce signal quality, it is recommended that a strainer (90008-425) is installed at the inlet of the meter as shown.



Installation Example

### Pipe System Considerations:

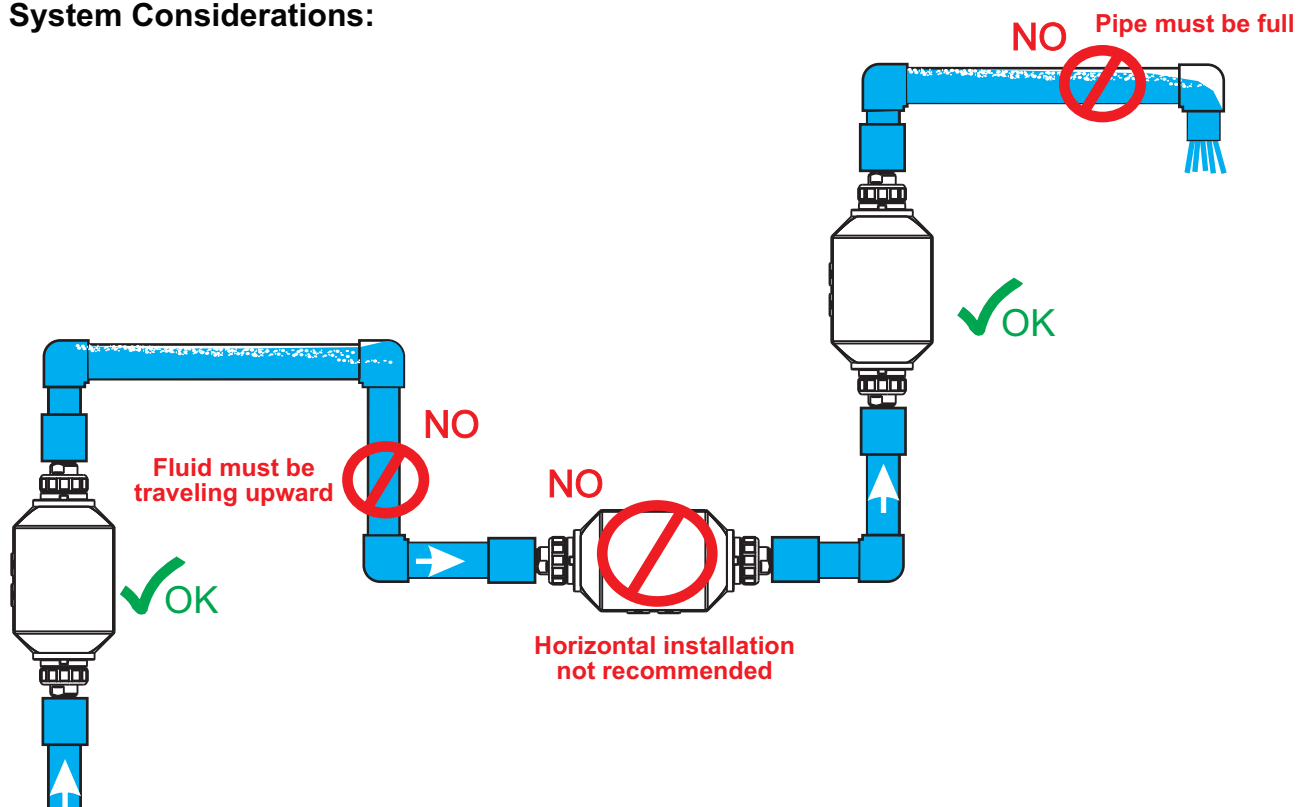

### Installation Requirements:

**1. Mounting Direction can cause inaccuracies!**

Meter must be installed in a vertical plane with fluid flowing in an upward direction to ensure accuracy.

**2. Vibration and heavy loads will damage the meter!**

Wall, floor and ceiling mounts and supports must be carefully aligned with the meter body and sturdy enough to support the plumbing and prevent vibration. Never allow the meter to support the weight of related piping.

**3. High pressures and temperatures will damage the meter!**

The maximum acceptable temperature and pressure is interdependent. The maximum acceptable working pressure is dependant on the actual fluid temperature. The maximum acceptable fluid temperature is dependant on the actual working pressure. (see Temperature vs. Pressure chart on page 3).

**4. Strainer Recommended!**

1/32" mesh strainer is recommended to be installed at the inlet of the meter. This will keep particles from entering the meter that could cause inaccurate readings.

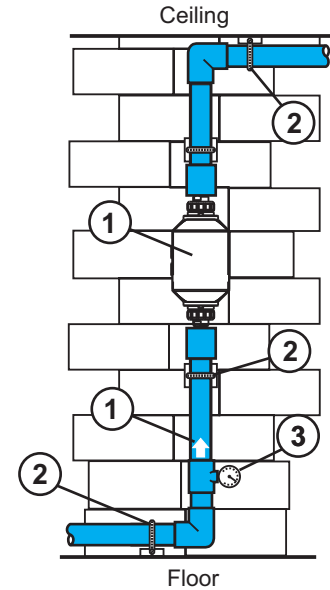

### 15.2 Product Dimensions

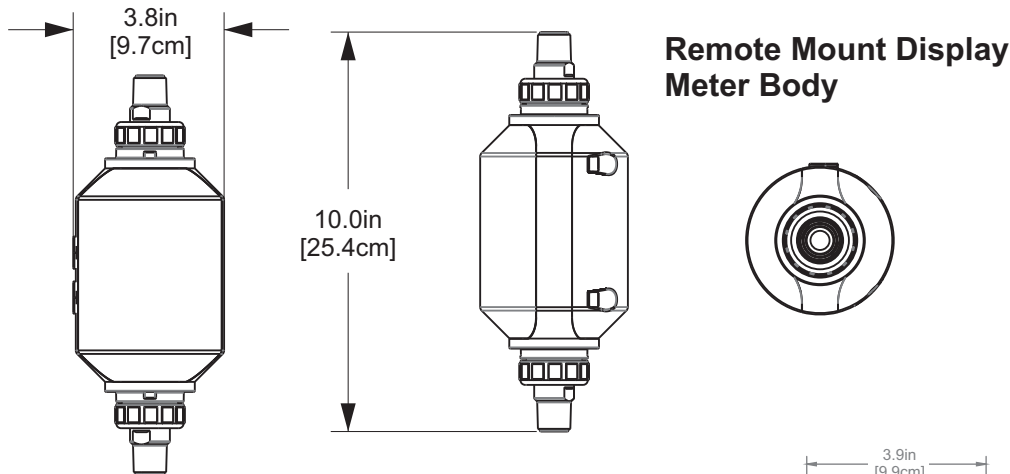

### Meter Mount Display Meter Body

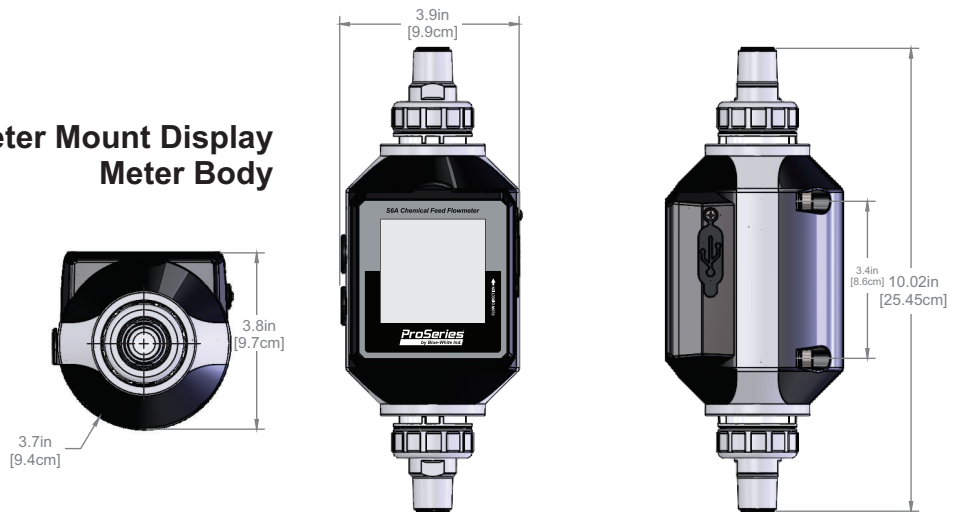

### 16.0 Maintenance and Service

- The S6A Chemical Feed meter requires very little maintenance.
- When the S6A Chemical Feed Flowmeter is removed from the system or an empty pipe condition causes the meter to dry out, always flush the meter with water before reinstalling.
- Although the S6A Chemical Feed Flowmeter is designed for outdoor conditions, a cool, dry location where the unit can easily be serviced is recommended.
- Service should be performed by factory trained personnel.

### 17.0 LCD Display for Meter Mount Display Model

The meter mount display model of the S6A Chemical Feed Flowmeter comes equipped with a 3.5" LCD display that will indicate the flow rate, totalized flow, and status of the device.

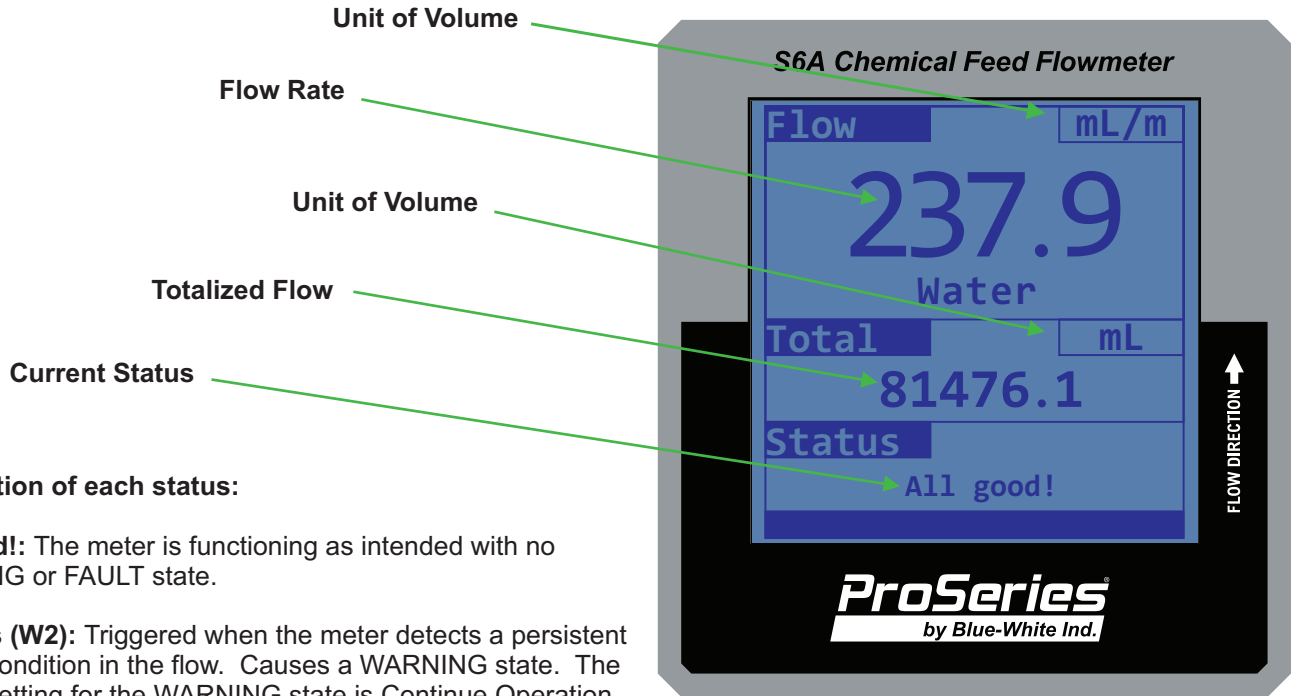

**Description of each status:**

**All Good!**: The meter is functioning as intended with no WARNING or FAULT state.

**Bubbles (W2)**: Triggered when the meter detects a persistent bubble condition in the flow. Causes a WARNING state. The default setting for the WARNING state is Continue Operation (see page 10, section 6.5.2).

**Poor/Low Signal (W3)**: Triggered when the meter detects a low or no signal. Often when the meter is not consistently fully filled with fluid.

**Empty Tube (W4)**: Triggered when the meter detects a low or no signal for a duration of at least 32 seconds. Causes a WARNING state. The default setting for the WARNING state is Continue Operation (see page 10, section 6.5.2).

**System Failure (F1)**: Triggered when the meter detects a hardware failure that is non recoverable. Causes a FAULT state. The default setting for the FAULT state is Halt Operation (see page 10, section 6.5.2).



## 18.0 Status LED for Remote Mount Display Model

The remote mount display model of the S6A Chemical Feed Flowmeter comes equipped with a visible multi-colored LED light that will indicate the status of the device.

In the below example the LED is solid green, indicating the meter is in a NORMAL state.

Current Status

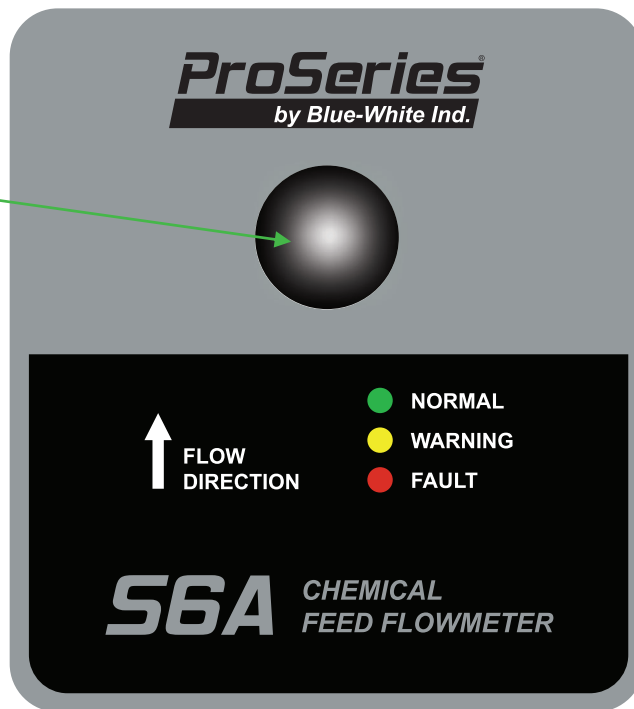

### Description of each status:

**NORMAL:** A solid green LED light. The meter is functioning as intended with no WARNING or FAULT state.

**WARNING:** A solid yellow LED light. Bubbles in the fluid line (code W2), poor signal (code W3), or empty tube (code W4) will trigger the WARNING state. The default setting for the WARNING state is Continue Operation (see page 10, section 6.5.2).

**FAULT:** A solid red LED light. A system failure (code F1), or invalid configuration settings (code F3) will trigger the FAULT state. The default setting for the FAULT state is Halt Operation (see page 10, section 6.5.2).

**Note:** A blinking red LED light indicates a hardware failure.

## 19.0 Troubleshooting

Error Code	Explanation	Troubleshooting
<b>W2 - Yellow WARNING Light</b>	Bubbles are present in the meter	- Prime system to remove bubbles - Recommend installing a strainer to break large bubbles up.
<b>W3 - Yellow WARNING Light</b>	Too many particulates are causing a poor signal	- Recommend installing a strainer to reduce particulates.
<b>F1 - Red FAULT Light (System Failure)</b>	Hardware failure has occurred.	- Power cycle meter - If problem persists, contact Blue-White Industries Ph: 714-893-8529
<b>W4 - Yellow WARNING Light (Empty Tube)</b>	Fluid is not present in the meter.	- Prime system to fill the meter - If problem persists, contact Blue-White Industries Ph: 714-893-8529
<b>F3 - Red FAULT Light</b>	Check system configuration.	- Contact Blue-White Industries Ph: 714-893-8529
<b>Blinking Red FAULT Light (System Failure)</b>	System failure has occurred.	- Power cycle meter - If problem persists, contact Blue-White Industries Ph: 714-893-8529
<b>Red FAULT Light persists</b>	meter had a fault and will not return to normal operation. Error codes in Blue-Central® are set to Halt Operation	- Adjust error codes in Blue-Central® to continue operation.

## 20.0 Replacement parts

### S6A Power Supply Kit (part number 72000-594)

ITEM NO.	PART NUMBER	DESCRIPTION	QTY
1	90008-723	U.K. Blade Power Supply	1
2	90008-513	Europe Blade Power Supply	1
3	90008-724	Australian Blade Power Supply	1
4	90008-743	Power Supply 120AC/5VDC 2000MA	1
5	90010-597	USB A-C Cable	1

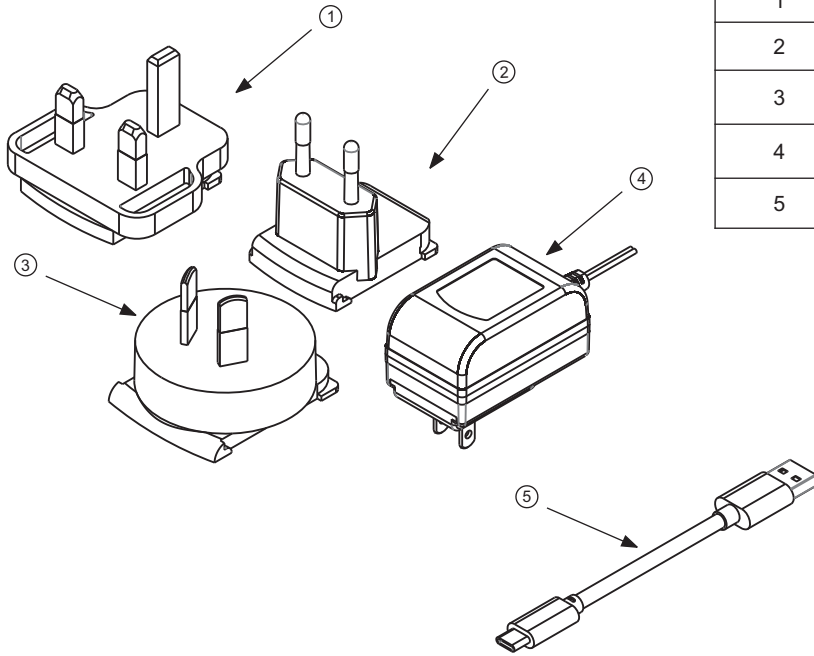

### S6A Fittings Kit

ITEM NO.	PART NUMBER	DESCRIPTION	QTY
1	76001-855	Adapter S6A PVC	2
2	90003-565	Cable Gland	2
3	90002-672	O-Ring 2-119 PVDF	2
4	91001-296	Adapter Elbow, .50 MNPT	2
5	91001-295	.50" Barb Adapter	2
6	91001-288	Adapter Elbow SM .50 M/NPT	2
7	91001-287	Adapter, SM.50 M/NPT	2
8	91001-301	Nut Union Molded PVDF	2

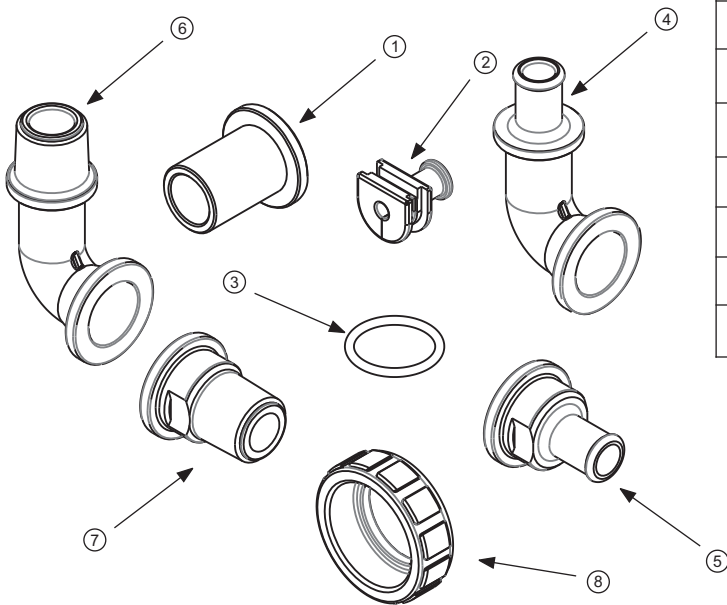

## 21.0 Product Matrix

Chemical Feed Flowmeter Model Number	
<b>S6A</b>	S6A Chemical Feed Flowmeter
Flow Range	
<b>1</b>	10-5000 mL/min (0.158-79.2 GPH)
<b>2</b>	100-10000 mL/min (1.58 -158.5 GPH)
Display options	
<b>1</b>	Remote Mount Display
<b>2</b>	Meter Mount Display
Elastomer Material (O-Rings)	
<b>V</b>	TFE/P & PVDF
<b>E</b>	EP & PVDF
meter Fittings	
<b>X</b>	Standard Equipment - Includes 1/2" I.D. Barb Fittings (Straight & Elbow Adapters), 1/2" MPT Fittings (Straight and Elbow Adapters), 1/2" PVC Slip Male Adapters.

<b>S6A</b>	<b>1</b>	<b>1</b>	<b>V</b>	<b>X</b>	<b>Sample Model Number</b>
------------	----------	----------	----------	----------	----------------------------

## Limited Warranty

- Blue-White S6A meters are warranted to be free from defects in material and workmanship for 24 months from date of factory shipment. WARRANTY COVERAGE IS LIMITED TO REPAIR OR REPLACEMENT OF THE DEFECTIVE meter ONLY. UNDER NO CIRCUMSTANCES SHALL BLUE-WHITE BE LIABLE FOR ANY CONSEQUENTIAL OR INCIDENTAL LOSSES OR DAMAGES THAT SHOULD ARISE FROM THE USE OF THE meter AND IN NO EVENT SHALL THE COMPANIES LIABILITY EXCEED THE PURCHASE PRICE PAID BY THE PURCHASER FOR THE PRODUCT.
- This warranty does not cover damage to the meter that results from misuse or alterations, nor damage that occurs as a result of improper installation.
- Blue-White assumes no liability for the acceptability of the meter in a specific application. THE USER MUST DETERMINE THE ACCEPTABILITY OF THE PRODUCT AND ITS FITNESS FOR USE IN THE SPECIFIC APPLICATION.
- meters are repaired at the factory only. Call or write the factory to receive a RMA (return materials authorization) number. Carefully pack the meter to be returned and write the RMA number on the outside of the shipping carton. Include a brief description of the problem and the application.
- Prepay all shipping costs. The factory does not accept C.O.D. Shipments. Damage that occurs during shipping is the responsibility of the sender.



Users of electrical and electronic equipment (EEE) with the WEEE marking per Annex IV of the WEEE Directive must not dispose of end of life EEE as unsorted municipal waste, but use the collection framework available to them for the return, recycle, recovery of WEEE and minimize any potential effects of EEE on the environment and human health due to the presence of hazardous substances. The WEEE marking applies only to countries within the European Union (EU) and Norway. Appliances are labeled in accordance with European Directive 2002/96/EC. Contact your local waste recovery agency for a *Designated Collection Facility* in your area.



**ProSeries®**  
**by Blue-White Ind.**

5300 Business Drive, Huntington Beach, CA 92649 USA

**Phone:** 714-893-8529 **FAX:** 714-894-9492

**E mail:** sales@blue-white.com or techsupport@blue-white.com **URL:** www.blue-white.com