

# **FLEXFLO**<sup>®</sup>

Peristaltic Metering Pump



## **Series M4**

<b>1.0</b>	<b>Introduction</b>	<b>4</b>	<b>11.0</b>	<b>Tubing</b>	<b>38</b>
1.1	What's in the box	5	11.1	Tube Information	38
<b>2.0</b>	<b>Engineering Specifications</b>	<b>6</b>	11.2	Tube Calibration	39
2.1	Output vs fluid viscosity	7	<b>12.0</b>	<b>Settings</b>	<b>40</b>
<b>3.0</b>	<b>Materials of Construction</b>	<b>8</b>	12.1	Pump Name	40
3.1	Wetted Components	8	12.2	Unit of Volume	41
3.2	Non-Wetted Components	8	12.3	Unit of Time	42
<b>4.0</b>	<b>Features</b>	<b>9</b>	12.4	Chemical Name	43
4.1	Agency Listings	9	12.5	Language	44
<b>5.0</b>	<b>Installation</b>	<b>10</b>	12.6	Pump Rotation Direction	45
5.1	Mounting Location	10	12.7	System Time	46
5.2	Mounting Dimensions	11	12.8	Passcode	47
5.3	Input Power Connections	12	12.9	Factory Reset	48
5.4	Wiring Terminals and I/O Schematics	13	<b>13.0</b>	<b>System</b>	<b>49</b>
<b>6.0</b>	<b>Layout</b>	<b>14</b>	13.1	System Information	49
6.1	Home Screen Layout	14	13.2	Firmware Update	50
6.2	Connector Layout	14	<b>14.0</b>	<b>Pump Maintenance</b>	<b>51</b>
6.3	M12 Connectors	15	14.1	Routine Inspection and Maintenance	51
6.4	IO Connectors	15	14.2	How to Clean and Lubricate the Pump	51
6.5	M12 Connectors Description	16	14.3	Removing Pump Head and Tubing	52
<b>7.0</b>	<b>Startup</b>	<b>18</b>	14.4	Pump Head Exploded View	53
7.1	Powering On/Off the pump	18	14.5	Tube Replacement	54
7.2	Welcome Screen	19	14.6	TFD (Tube Failure Detection)	55
<b>8.0</b>	<b>Input Setup</b>	<b>20</b>	<b>15.0</b>	<b>Replacement Parts</b>	<b>56</b>
8.1	Manual Input	20	15.1	Replacement Parts	56
8.2	4-20 mA Input	21	15.2	Tube Selection Matrix	57
8.3	Frequency Input	22	<b>16.0</b>	<b>Accessories</b>	<b>58</b>
8.4	Pulse Input	23	<b>17.0</b>	<b>Warranty</b>	<b>61</b>
8.5	Remote Start/Stop	24	<b>APPENDIX A: ACRONYMS</b>	<b>62</b>	
8.6	Flow Verification Sensor (FVS)	25	<b>APPENDIX B: MODEL NUMBER MATRIX</b>	<b>63</b>	
8.7	Prime the Pump	26			
8.8	Auto Prime the Pump	27			
8.9	Time of Day	28			
8.10	Revolution Alarm	29			
<b>9.0</b>	<b>Output Setup</b>	<b>30</b>			
9.1	4-20 mA Output	30			
9.2	Frequency Output	31			
9.3	Relay & Contact Output	32			
<b>10.0</b>	<b>Industrial Protocols</b>	<b>33</b>			
10.1	Control and Status Mapping for Profibus and EtherNet/IP	33			
10.2	Control and Status Mapping for Modbus TCP	34			
10.3	EtherNet/IP	35			
10.4	Modbus TCP	36			
10.5	Profibus	37			

# READ THE ENTIRE OPERATING MANUAL PRIOR TO INSTALLATION AND USE.



+1 (714) 893 - 8529



[sales@blue-white.com](mailto:sales@blue-white.com)



[customerservice@blue-white.com](mailto:customerservice@blue-white.com)



5300 Business Drive  
Huntington Beach, CA 92649

Congratulations on purchasing the M4 FLEXFLO® variable speed Peristaltic Metering Pump.

Your FLEXFLO® M4 pump is pre-configured for the tubing that shipped with your metering pump. The tubing assembly has an Identification number printed for easy re-order.

**Please Note:** Your new pump has been pressure tested at the factory with clean water before shipping. You may notice trace amounts of clean water in the pre-installed tube assembly. This is part of our stringent quality assurance program at Blue-White Industries.

For more information please visit us at: [www.blue-white.com](http://www.blue-white.com)

For videos and tutorials please visit as at:  
<https://www.blue-white.com/resources/videos>



## 1.1 What's In The Box

The following items are included with every M4 peristaltic metering pump:

M4 Peristaltic Pump



USB Flash Drive With Instruction Manual



Standard Mounting Brackets



Extended Mounting Brackets



Tube Installation Tool



Spare Tubing



<b>Maximum Working Pressure (excluding pump tubes)</b>	125 psig (8.6 bar) <b>NOTE:</b> See individual pump tube assembly maximum pressure ratings.
<b>Maximum Fluid Temperature (excluding pump tubes)</b>	185 °F (85 °C) <b>NOTE:</b> See individual pump tube assembly max. temperature ratings.
<b>Maximum Viscosity</b>	12,000 Centipoise
<b>Maximum Suction Lift</b>	30 ft. Water, 0 psig (9.14 m, 0 bar)
<b>Ambient Operating Temperature</b>	14 °F to 115 °F (-10 °C to 46 °C)
<b>Ambient Storage Temperature</b>	-40 °F to 158 °F (-40 °C to 70 °C)
<b>Operating Voltage</b>	115VAC/60Hz, 1ph (2.0 Amp Maximum)
	230VAC/60Hz, 1ph (1.0 Amp Maximum)
	220VAC/50Hz, 1ph (1.0 Amp Maximum)
	240VAC/50Hz, 1ph (1.0 Amp Maximum)
	230VAC/50Hz, 1ph (1.0 Amp Maximum)
<b>Power Cord Options</b>	115V60Hz = NEMA 5/15 (USA)
	230V60Hz = NEMA 6/15 (USA)
	220V50Hz = CEE 7/VII (EU)
	240V50Hz = AS 3112 (Australia/New Zealand)
	230V50Hz = BS 1363/A (UK)
<b>Motor</b>	Brushless DC, 1/4 hp
<b>Motor Speed Adjustment Range</b>	10,000:1 (0.01% - 100% motor speed) Max RPM = 125
<b>Motor Speed Adjustment Resolution</b>	0.1% increments > 1% motor speed and < 100%
	0.01% increments < 1% motor speed
<b>Display</b>	5" touchscreen color LCD, UV resistant.
<b>Display Languages</b>	English, Spanish, French, German, and Portuguese selectable
<b>Maximum Overall Dimensions</b>	12-1/8"W x 15-1/4"H x 16-1/2"D (30.8W x 38.8H x 41.9D cm)
<b>Product Weight</b>	45.5 lb. (20.64 Kg)
<b>Security</b>	Programmable 6-digit password
<b>Approximate Shipping Weight</b>	50 lb. (22.68 Kg)
<b>Enclosure</b>	NEMA 4X (IP66), Polyester powder coated aluminum & Noryl
<b>RoHS Compliant</b>	Yes
<b>Standards</b>	cETLus, CE, NSF61

## 2.1 OUTPUT VERSUS FLUID VISCOSITY

Fluid viscosity and motor RPM both have an effect on fluid output. For your reference the charts below display the various tubes we offer and their output at different viscosities and different motor RPM. All testing was conducted with a three foot suction lift.

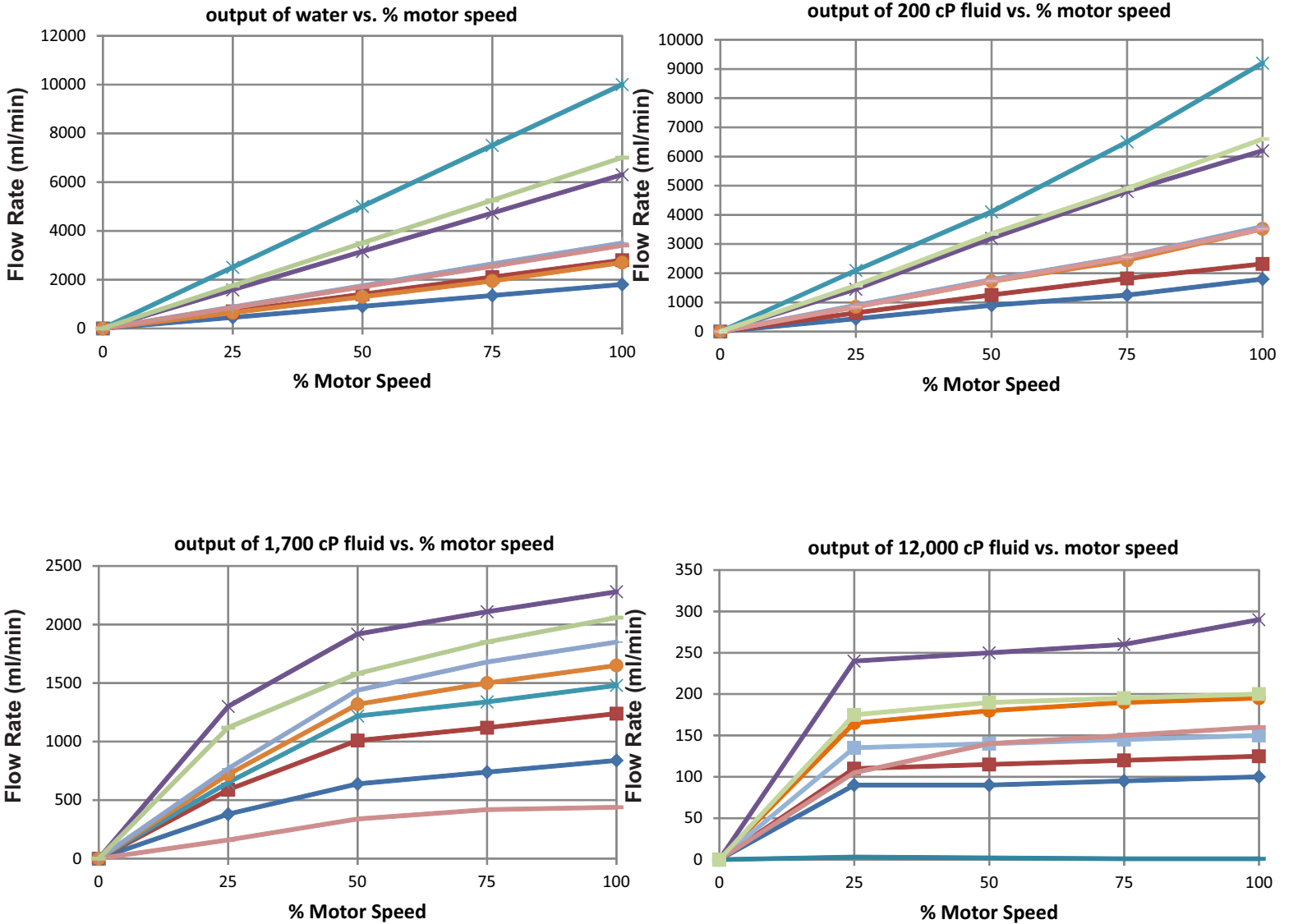

**Tube Material**

- ◆ BNH
- BNJ
- ✕ BNL
- \* BNP
- MTK
- + MGK

+

---

**3.1 Non-Wetted Components**

---

**Enclosure:** 413 Aluminum (Polyester powder coated) & Noryl

---

**Pump Head:** Valox® (PBT) thermoplastic

---

**Pump Head Cover:** Polycarbonate

---

Permanently lubricated sealed motor shaft support ball bearing.

---

**Cover Screws:** Stainless steel, polypropylene cap

---

**Roller Assembly:**

---

Rotor: Valox® (PBT)

---

Rollers: Nylon

---

Roller Bearings: SS Ball bearings

---

**Motor Shaft:** Chrome plated steel

---

**TFD System Sensor:** Hastelloy C-276

---

**Power Cord:** 3 conductor, SJTW-A water-resistant

---

**Tube Installation Tool:** GF nylon

---

**Mounting Brackets and Hardware:** 316 Stainless steel

---

**3.2 Wetted Components**

---

**Pump Tube Assembly:**

---

Tubing: Flex-A-Prene®, Flex-A-Chem® or Flex-A-Thane®

---

Adapter Fittings: PVDF

### 4.1 Agency Listings



This pump is ETL listed to conform to the following: UL Standard 778 as a motor operated water pump. CSA Standard C22.2 as process control equipment

**Intertek**



This pump complies to the Machinery Directive 2006/42/EC, BS, EN 60204-1, Low Voltage Directive 2014/35/EU BS EN 61010-1, EMC Directive 2014/30/EU, BS EN 50081-1/BS EN 50082-1.



Certified to NSF/ANSI Standard 61







This pump is certified to NSF/ANSI Standard 61- Drinking Water System Components - Health Effects

Symbol	Description
	Warning (Risk of electric shock)
	Caution (Refer to the user's guide)
	Ground, Protective Conductor Terminal

### ENCLOSURE RATING

**NEMA 4X** Constructed for either indoor or outdoor use to provide a degree of protection to personnel against incidental contact with enclosed equipment; to provide a degree of protection against falling dirt, rain, sleet, snow, windblown dust, splashing water, and hose-directed water; and that will be undamaged by external formation of ice on enclosure.

**IP66** No ingress of dust; complete protection against contact. Water projected in powerful jets against enclosure from any direction shall have no harmful effects.

<b>CAUTION</b> 	The pump should be serviced by qualified persons only. If equipment is used in a manner not specified in this manual, the protection provided by the equipment may be impaired.
<b>CAUTION</b> 	Risk of chemical overdose. Be certain pump does not overdose chemical during backwash and periods of no flow in circulation system.
<b>CAUTION</b> 	Always wear protective clothing, face shield, safety glasses and gloves when working on or near your metering pump. Additional precautions should be taken depending on solution being pumped. Refer to MSDS precautions from your solution supplier.
<b>CAUTION</b> 	All diagrams are strictly for guideline purposes only. Always consult an expert before installing metering pump on specialized systems. Metering pump should be serviced by qualified persons only.
<b>CAUTION</b> 	Be sure that installation does not constitute a cross connection with drinking water supply. Check your local plumbing codes.
<b>CAUTION</b> 	The pump should be supplied by an isolating transformer or RCD (operating current less or equal 30 mA).

## 5.1 Mounting Location

1. Choose an area located near the chemical supply tank, chemical injection point, and electrical supply. Also, choose an area where the pump can be easily serviced.
2. Finding a secure surface and using the provided mounting hardware, mount the pump close to the injection point. Keep the inlet (suction) and outlet (discharge) tubing as short as possible. Longer discharge tubing increases back pressure at pump head.

**NOTE:** Mounting the pump lower than the chemical container will gravity-feed chemical into it. This “flooded suction” installation will reduce output error due to increased suction lift. A shut-off valve, pinch-clamp, or other means to halt gravity-feed to the pump must be installed during servicing.

**NOTE:** Install a back flow prevention check valve at the discharge side of the pump to prevent the system fluid from flowing back through pump during tube replacement or during tube rupture.

**NOTE:** It is recommended to have a pressure relief valve at the discharge side of the of pump to prevent premature wear and damage to the pump tube, in the event that the discharge line becomes blocked.

**NOTE:** The pump does not require back pressure. Keep the discharge pressure as low as possible to maximize the tube life.

## 5.2 Pump Dimensions

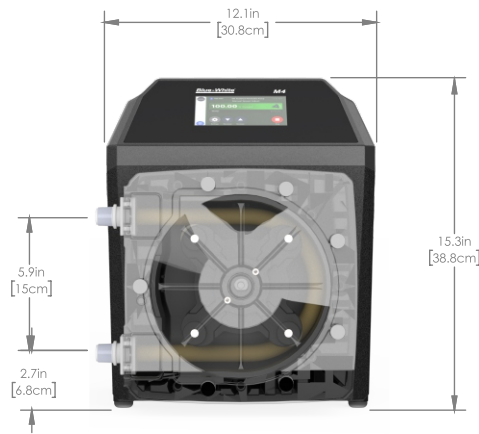

Front View

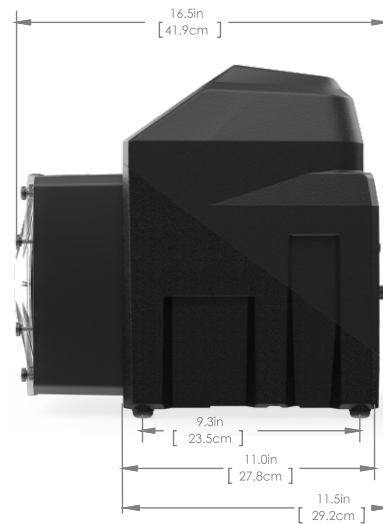

Side View

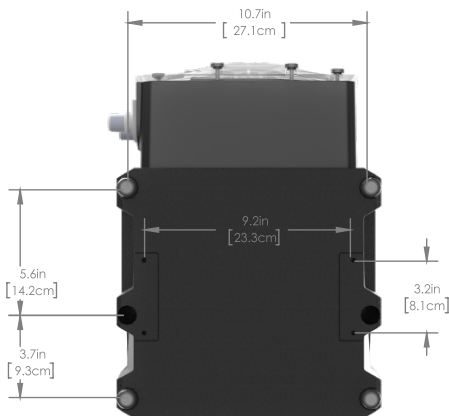

Bottom View

### Mounting Hole Spacings (for standard and extended type brackets)

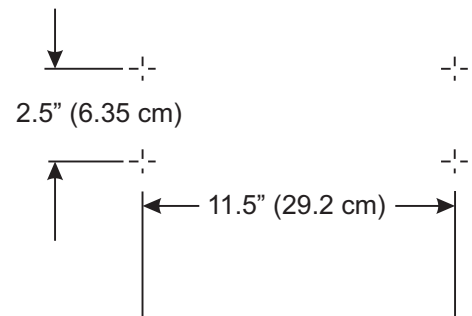

Maximum bolt hole size  
0.200" diameter (4 places)



### Extended Brackets

Stainless Steel extended brackets allow the pump to be securely mounted to most any surface; floor, shelf, or skid. Brackets lift the pump up 4-1/2 inches (11.43 cm), for easy pump access in hard to reach areas.

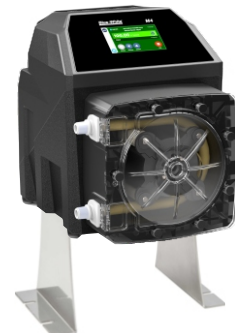
- Raise metering pump 4-1/2 inches (11.43 cm) off ground or a surface.
- Made out of tough Stainless Steel.
- Provides a stable mounting surface.



### 5.3 Input Power Connections

<b>WARNING</b> 	Risk of electric shock – cord connected models are supplied with a grounding conductor and grounding-type attachment plug. To reduce risk of electric shock, be certain that it is connected only to a properly grounded, grounding-type receptacle.
<b>WARNING</b> 	Electrical connections and grounding (earthing) must conform to local wiring codes.
<b>WARNING</b> 	Risk of electric shock - Disconnect electricity before removing the wiring compartment cover.

- Be certain to connect pump to proper supply voltage. Using incorrect voltage will damage pump and may result in injury. Voltage requirement is printed on pump serial label.
- Input power range is 96VAC to 264VAC 50/60 Hz.
- Voltage Selection is automatically detected and adjusted by power supply. No mechanical switch necessary.
- Use voltage your power cord is rated for.
- Power cord models are supplied with a ground wire conductor and a grounding type attachment plug (power cord). To reduce risk of electric shock, be certain that power cord is connected only to a properly grounded, grounding type receptacle.
- Be sure all M12 wiring cable glands are properly installed and sealed.
- Never strap control (input / output) cables and power cables together.
- **Power Interruption:** This pump has a user programmable auto-restart feature which will can either restore the pump to the operating state it was in when power was lost or require a user action to restart.

**Note:** When in doubt regarding your electrical installation, contact a licensed electrician.



### 5.4 Wiring Terminals and I/O Schematics

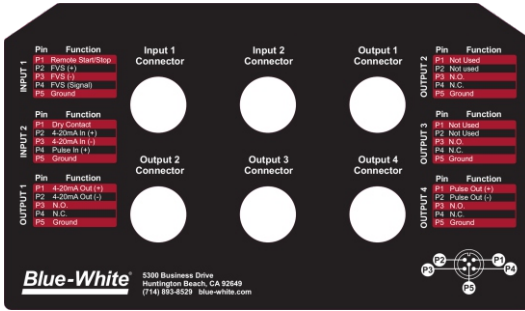

**Risk of electric shock - All wiring must be insulated and rated 300V minimum.**

**Shielded cables should be used on all input signal wires.**

FUNCTION	M12 Connector	PIN #	RATING	BLOCK DIAGRAM
INPUT: 4-20 mA	INPUT #2	2	(+) POSITIVE	
		3	(-) NEGATIVE	
INPUT: FREQUENCY, AC SINE WAVE, TTL, CMOS	INPUT #2	4	(+) POSITIVE	
		5	(-) NEGATIVE	
INPUT: FVS SYSTEM (FLOW VERIFICATION SENSOR) FV SENSOR ONLY	INPUT #1	2	(+) POSITIVE	
		3	(-) NEGATIVE	
		4	SIGNAL	
INPUT: FVS SYSTEM (FLOW VERIFICATION SENSOR) FS or FP MICRO-FLO FLOWMETER ONLY	INPUT #1	2	(+) POSITIVE	
		3	(-) NEGATIVE	
		4	SIGNAL	
INPUT: REMOTE START/STOP DRY CONTACT C PRIMARY	INPUT #1	1	(+) POSITIVE	
		5	(-) NEGATIVE	
INPUT: AUTO-PRIME/ DRY CONTACT C SECONDARY	INPUT #2	1	(+) POSITIVE	
		5	(-) NEGATIVE	
OUTPUT: 4-20 mA	OUTPUT #1	1	(+) POSITIVE	
		2	(-) NEGATIVE	
OUTPUT: FREQUENCY- OPEN COLLECTOR	OUTPUT #4	1	(+) POSITIVE	
		2	(-) NEGATIVE	
OUTPUT: CONTACT CLOSURE #1	OUTPUT #1	3	NORMALLY OPEN	
		4	NORMALLY CLOSED	
		5	COMMON (GROUND)	
OUTPUT: CONTACT CLOSURE #2	OUTPUT #3	3	NORMALLY OPEN	
		4	NORMALLY CLOSED	
		5	COMMON (GROUND)	
OUTPUT: CONTACT CLOSURE #3	OUTPUT #4	3	NORMALLY OPEN	
		4	NORMALLY CLOSED	
		5	COMMON (GROUND)	
OUTPUT: RELAY 6 AMP	OUTPUT #2	3	NORMALLY OPEN	
		4	NORMALLY CLOSED	
		5	COMMON (GROUND)	

## 6.1 HOME SCREEN LAYOUT

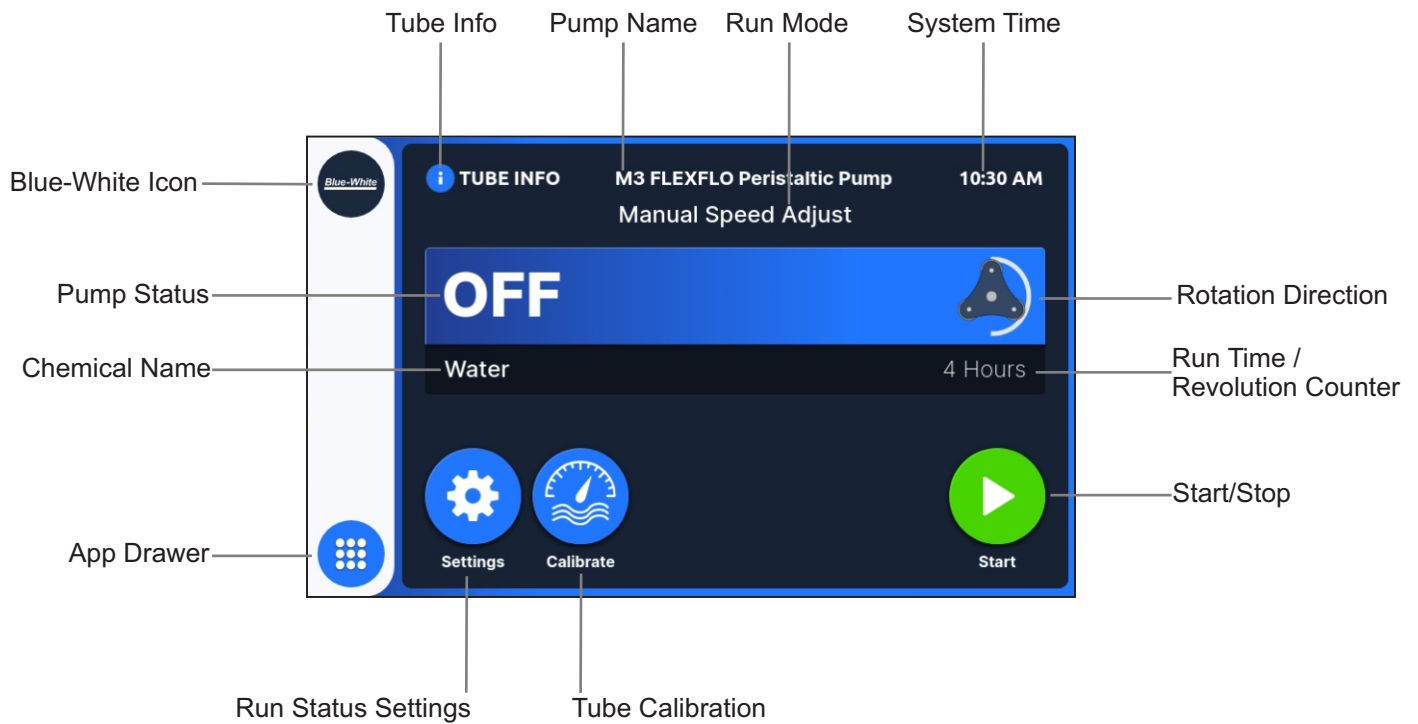

## 6.2 APP SCREEN LAYOUT

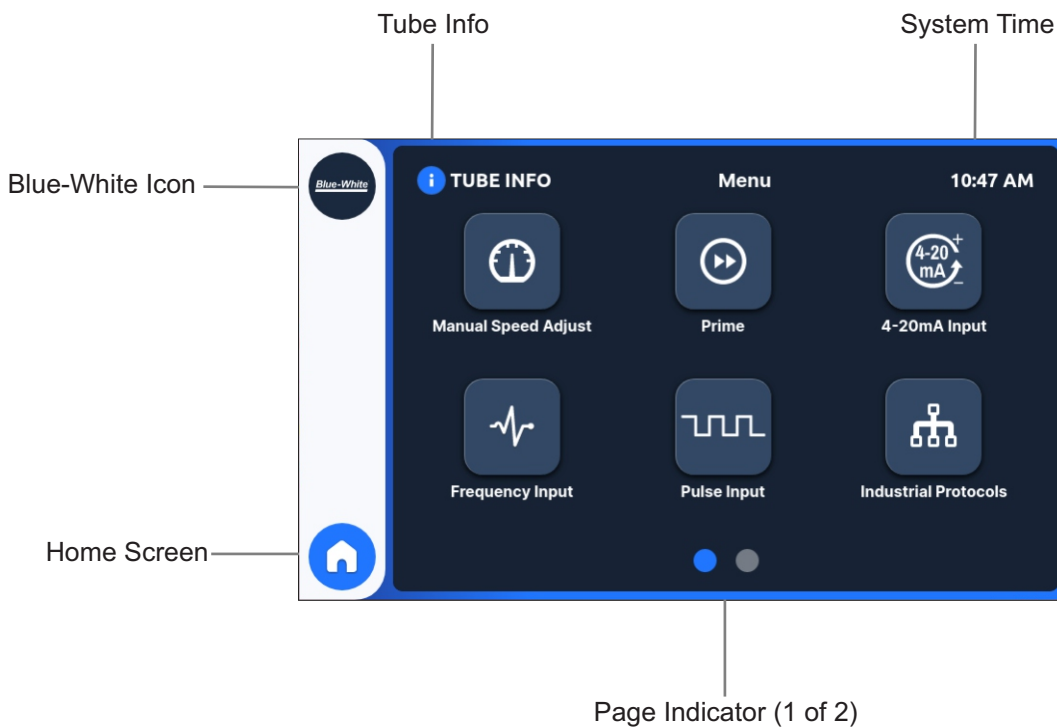

6.3 M12 Connector

Pump (Rear Upper Panel)

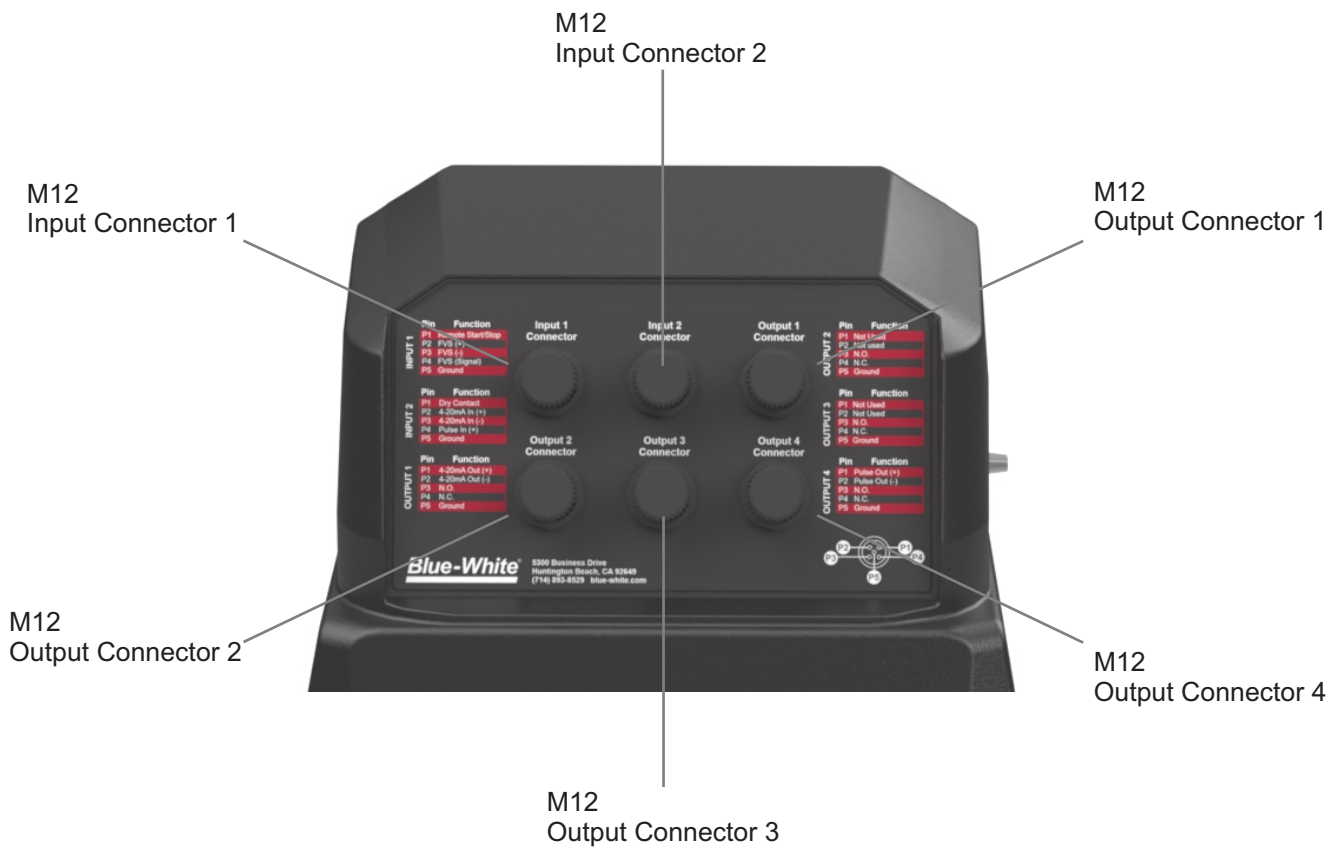

6.4 IO Connection

Pump (Rear Lower Panel)

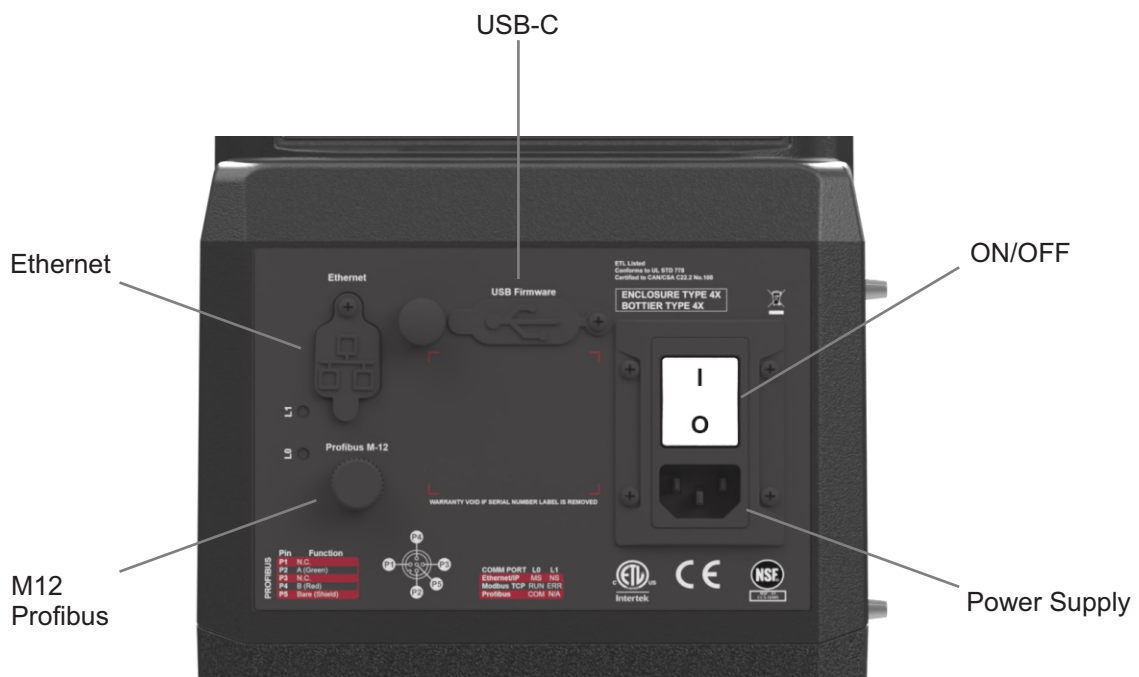

## 6.5 M12 Connector

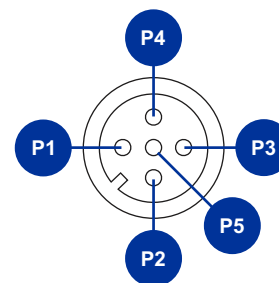
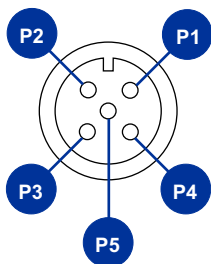

M12 Input/Output Connector

M12 Profibus Connector

### M12 Input Connector 1

PIN	Function	Specifications	Reference
P1	Remote Start/Stop	No Voltage	
P2	FVS (+)	15 VDC @ 60 mA Supply	Power FVS Sensor
P3	FVS (-)	DC GND (0 VDC)	FVS Ground Input
P4	FVS (Signal)	Input Signal	FVS Input Signal
P5	Ground	DC Ground	0 VDC

### M12 Input Connector 2

PIN	Function	Specifications	Reference
P1	Dry Contact	N.O. Dry Contact Closure	Open= Stop Gnd= Run
P2	4-20mA In (+)	120Ω Impedance Loop Ref. to Ground	
P3	4-20mA In (-)	DC GND (0 VDC)	
P4	Pulse In (+)	0-1000 Hz (AC. Square Wave) Ref. to Ground	
P5	Ground	DC GND (0 VDC)	

### M12 Output Connector 1

PIN	Function	Specifications	Reference
P1	4-20mA Out (+)		250Ω max load
P2	4-20mA Out (-)	DC GND (0 VDC)	
P3	N.O.	Relay Out, N.O. Contact 1 Amp @ 125 VAC	.8 Amp Max @ 30VDC 1 Amp @ 125 VAC
P4	N.C.	Relay Out, N.C. Contact	.8 Amp Max @ 30VDC 1 Amp @ 125 VAC
P5	Ground	Relay Out, COM Contact	

PIN	Function	Specifications	Reference
P1	Not Used		
P2	Not Used		
P3	N.O.	Relay Out, N.O. Contact	6 Amp Max @ 250VAC, 5 Amp MAX @ 30VDC
P4	N.C.	Relay Out, N.C. Contact	6 Amp Max @ 250VAC, 5 Amp MAX @ 30VDC
P5	Ground	Relay Out, COM Contact	

**M12 Output Connector 3**

PIN	Function	Specifications	Reference
P1	Not Used		
P2	Not Used		
P3	N.O.	Relay Out, N.O. Contact	.8 Amp Max @ 30VDC 1 Amp @ 125 VAC
P4	N.C.	Relay Out, N.C. Contact	.8 Amp Max @ 30VDC 1 Amp @ 125 VAC
P5	Ground	Relay Out, COM Contact	

**M12 Output Connector 4**

PIN	Function	Specifications	Reference
P1	Pulse Out (+)	0-1000 Hz (AC. Square Wave) Ref. to Ground	
P2	Pulse Out (-)	DC GND (0 VDC)	
P3	N.O.	Relay Out, N.O. Contact	.8 Amp Max @ 30VDC 1 Amp @ 125 VAC
P4	N.C.	Relay Out, N.C. Contact	.8 Amp Max @ 30VDC 1 Amp @ 125 VAC
P5	Ground	Relay Out, COM Contact	

**M12 Profibus Connector**

PIN	Function	Specifications	Reference
P1	VP		+5V supply for terminating resistors
P2	RxD/TxD-N		Data line minus (A-line)
P3	DGND		Data ground
P4	RxD/TxD-P		Data line plus (B-line)
P5	Shield		Ground connection

*Note:*

*M12 connectors not included with product.*

*Input/Output Connectors requires any A-Type M12 connector with 5 position female sockets*

*Profibus Connectors requires any B-Type M12 connector with 5 position female sockets*

*If the pump is the last bus device connected to the PROFIBUS cable it must be terminated using terminating resistor (PROFIBUS standard EN 50170).*

## 7.1 Powering On The Pump

The M4 is equipped with a rocker switch to power ON/OFF the pump. Ensure that the power cord is securely plugged into the corresponding power source before powering on the pump.

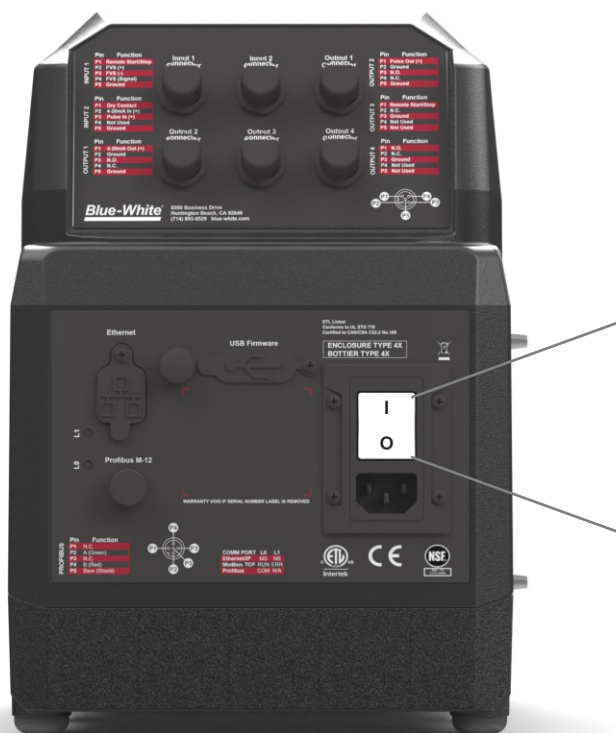

"I" is pressed to turn on the pump

"O" is pressed to turn off the pump

## 7.2 Welcome Screen

The first time the pump is powered on, or after a factory reset, the pump will boot up to the Welcome Screen. Follow the onscreen instructions to configure your M4 pump. Refer to section 11 of this manual to change any of these options after you have finished the initial configuration.

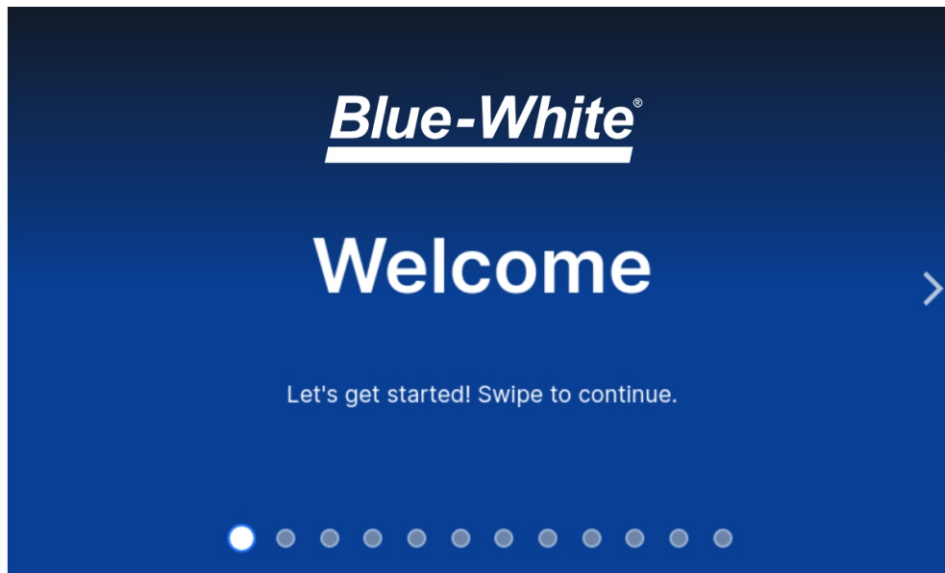

### Welcome Screen Configuration

# 1

Local Language

# 2

Set Time

- Local Date
- Local Time Zone
- Local Time

# 3

Set Name

- Pump Name
- Chemical Name

# 4

Set Units

- Unit of Volume
- Unit of Time

# 5

Set Tube Type

# 6

Set User Password

## 8.1 Manual Speed Adjust

This input mode allows the user to set a specific speed and the pump will run at that speed until stopped. There are up and down arrows on the home screen to incrementally adjust the speed of the motor.

Default: Percent motor speed.

Also Available: Percent motor speed  
RPM  
Flow rate

---

### To Enable Manual Speed Adjust:

1



Open the **App Drawer**

2



Select **Manual Speed Adjust**

3



Select **Start** to enable Manual Speed

4

Tap on the feed rate to cycle through to the option you want to manually adjust

- Percent motor speed
- RPM
- Flow rate

5



Adjust manual speed by selecting **Increase** or **Decrease**

*Option: Stop pump and select settings to input desired motor speed.*



*Confirm by pressing "Save"*



## 8.2 4-20mA Input

This input mode allows the user to set a range of mA input signals to a given motor speed, flow rate or rpm. Used to remotely control the pump with an incoming 4-20mA signal.

Four points on the slope must be defined:

- 1) a low mA value
- 2) an output rate at the low mA value
- 3) a high mA value
- 4) an output rate at the high mA value

Default settings:                      4mA = 0% motor speed  
   20mA = 100% motor speed

---

### To Enable 4-20mA Input:

1



Open the **App Drawer**

2



Select **4-20mA Input**

3



Select **Settings** to adjust 4-20mA input values

4

Confirm by selecting **Save**

5



Select **Start** to enable 4-20mA Input

*Option: Stop the pump and select the graph icon to easily adjust sliders to desired settings*

Confirm by pressing "Save"



### 8.3 Frequency Input

This input mode is used to remotely control the pump with an incoming high speed frequency signal.

Four points on the slope must be defined:

- 1) a low Hz value
- 2) an output rate at the low Hz value
- 3) a high Hz value
- 4) an output rate at the high Hz value

Default settings:           0 (Hz) = 0% motor speed  
                                  1000 (Hz) = 100% motor speed

---

#### To Enable Frequency Input:

**1**

Open the **App Drawer**

**2**

Select **Frequency Input**

**3**

Select **Settings** to adjust  
Frequency Input

**6**

Confirm by pressing **Save**

**5**

Select **Start** to enable  
Frequency Input

*Option: Stop pump and select graph icon to easily adjust sliders to desired settings*



Confirm by pressing "Save"

## 8.4 Pulse Input

This input mode allows the user to trigger the pump to dispense a measured amount of chemical (Amount Per Trigger) over a specific period of time (Pump On Time), after a specific number of pulses (Pulses Count Trigger). Used to remotely control the pump with an incoming pulse signal.

Default settings: Pulse Count Trigger = 1

Pump On Time = 2.5 seconds

Amount Per Trigger = Fluid supplied per trigger

---

### To Enable Pulse Input:

**1**   
Open the **App Drawer**

**2**   
Select **Pulse Input**

**3**   
Select **Settings** to adjust Pulse Input

- Input value for Pulse Count Trigger
- Input value for Amount Per Trigger
- Input value for Pump On Time

**4**  
Confirm by pressing **Save**

**5**   
Select **Start** to enable

**6**  
Pump will be in **Standby Mode**

## 8.5 Remote Start/Stop

This input mode is used to remotely start and stop the pump using a close=stop or open=stop signal.

Primary Remote Switch - Used to Start/Stop the pump

Secondary Remote Switch - Used in conjunction with a pressure switch or level switch

Default settings: Disabled

Dry Contact Closure (no voltage required)

---

### To Enable Remote Start/Stop:

1



Open the **App Drawer**

2



Select **Settings**

3



Select **Remote Start/Stop**

4

Set **Remote Switch**

- Disable
- Normally Open (Closed to stop the pump)
- Normally Closed (Open to stop the pump)

5

Set **Secondary Remote Switch**

- Disable
- Enable

6

Confirm by pressing **Save Pump** will be in Standby Mode.

---

**IMPORTANT:** To begin operation, press the START button to place pump in STANDBY. The display background will turn yellow indicating the pump has been stopped remotely. When the pump is started by the remote contact, the display background will turn green.

**IMPORTANT:** If the Remote Start/Stop Input is enabled, the pump will display STANDBY if the pump has been stopped by the Remote Start/Stop. **Please use caution in this mode as the pump may Start at anytime. If you must perform maintenance to the pump, Press STOP button.**

## 8.6 Set FVS (Flow Verification System)

This input mode is used to monitor the pump fluid input. If the pump does not dispense fluid when pump head rotor is turning, the pump will go into an alarm mode and stop. FVS requires a sensor that is connected to the inlet of the pump to monitor the fluid input. Blue-White offers two flow verification sensors: [The MS6](#) & [The MICRO-FLO Flow Meter](#) that easily install into the inlet of the M4.

Default settings: Disabled

When enabled set trigger display (in seconds)

---

### To Enable FVS:

1



Open the **App Drawer**

2



Select **Settings**

3



Select **FVS**

4

Enable **FVS Input**

5

Set **Desired Trigger Delay**  
(1-1000 seconds)

6

Confirm by pressing **Save**

## 8.7 Prime

This mode allows the user to prime the pump at 100% motor speed for sixty seconds. After the prime is complete the pump will remain in this mode ready to be primed again.

To exit: select another input method.

---

### To Prime The Pump:

1



Open the **App Drawer**

2



Select **Prime**

3



Select **Start** to Prime the pump

4

Pump will run at 100% motor speed for sixty seconds

5

Pump will remain in **Prime Input**

## 8.8 Auto-Prime

This mode will allow the user to prime the pump remotely using the dry contact. Both prime duration and percent motor speed is configurable.

Default settings: 60 Seconds at 100% Motor Speed

---

### To Enable Auto-Prime:

**1**   
Open the **App Drawer**

**2**   
Select **Settings**

**3**   
Select **Auto-Prime**

**4**  
Enable **Auto-Prime**

**5**  
Input Values  
•Prime duration (in seconds)  
•Percent Motor Speed

**6**  
Select **Save** to save the settings

## 8.9 Time of Day

This mode allows the user to run the pump at a specific motor speed for a specific length of time beginning at a specific time of day.

Three values to be defined:

- 1) Percent Motor Speed
- 2) Run time (in minutes)
- 3) Time of Day that the pump will turn on

---

### To Enable Time of Day:

# 1



Open the **App Drawer**

# 2



Select **Time of Day**

# 3



Select **Settings** to configure

# 4

### Input Values

- Motor Speed (percentage)
- Run Time (in minutes)
- Time of Day

# 5

Select **Save** to save the settings

*Verify the time on the pump is in synch with your local time zone*



## 8.10 Revolution Alarm

This mode will allow the user to set an alert once a set number of revolutions has been reached. One of the primary factors effecting tube life is the number of revolutions the tube has operated. The M4 includes a roller revolution counter. A revolution alarm set point can be inputted which will alert the user when the tube should be serviced. When the set point is reached, the pump will display “Revolution Count Exceeded”

however **THE PUMP WILL NOT STOP**

Default settings: Amount will vary depending on tube that is installed

---

### To Enable Revolution Alarm:

1



Open the **App Drawer**

2



Select **Settings**

3



Select **Revolution Alarm**

4

Enable **Revolution Alarm**

5

Input Values

•Amount of Revolutions

6

Select **Save** to save the settings

## 9.1 Set 4-20mA Output

This output sends a configurable 4-20mA. This feature can be used to control other pumps (in sync / proportionally), data logging systems, and other external devices for plant automation.

Four points on the slope must be defined:

- 1) a low mA value
- 2) an output rate at the low mA value
- 3) a high mA value
- 4) an output rate at the high mA value

Default settings:                      4mA = 0 percent motor speed  
   20mA = 100 percent motor speed

---

### To Enable 4-20mA Output:

**1**

Open the **App Drawer**

**2**

Select **Outputs**

**3**

Select **4-20mA Output**

**4**

Enable **4-20mA Output**

**5**

Set desired values for the four points that is required.

**6**

Confirm by pressing **Save**

*Option: Stop the pump and select the graph icon to easily adjust sliders to desired settings*

Confirm by pressing "Save"



## 9.2 Frequency Output

This output sends a configurable high speed frequency signal. This feature can be used to control other pumps (in sync / proportionally), data logging systems, and other external devices for plant automation.

Four points on the slope must be defined:

- 1) a low Hz value
- 2) an output rate at the low Hz value
- 3) a high Hz value
- 4) an output rate at the high Hz value

Default settings:                      0 Frequency (Hz) = 0 percent motor speed  
   1000 Frequency (Hz) = 100 percent motor speed

---

### To Enable Frequency Output:

**1**

Open the **App Drawer**

**2**

Select **Outputs**

**3**

Select **Frequency Output**

**4**

Enable **Frequency Output**

**5**

Set **Desired Values**

**6**

Confirm by pressing **Save**

*Option: Stop the pump and select the graph icon to easily adjust sliders to desired settings*

Confirm by pressing "Save"



## 9.3 Relay & Contacts

This feature is used to assign alarms to relay & contact closures

Four values to be defined:

- 1) Contact #1
- 2) Contact #2
- 3) Contact #3
- 4) Relay Output

### To Enable Relay & Contacts:

# 1



Open the **App Drawer**

# 2



Select **Outputs**

# 3



Select **Relay & Contacts**

# 4

Set **Desired Values**  
(refer to chart below)

- Contact #1
- Contact #2
- Contact #3
- Relay Output

# 5

Confirm by pressing **Save**

<b>Selection:</b>	<b>Contact energizes when:</b>
Pump Run/Stop	Motor turning (roller assembly is rotating)
Monitor Input	Incoming analog or digital signal is not received or out of range
Monitor Output	Outgoing analog or digital signal not transmitted or out of range
Monitor Run/Fail	Motor fails to respond to commands
4-20 In Active	4-20mA mode is running
Frequency In Active	Frequency mode is running
Manual Speed Active	Manual Speed mode is running
Pulse In Active	Pulse In mode is running
Prime Active	Prime mode is running
FVS	After the programmed delay time pulses are not received from flow sensor.
TFD	Tube failure is detected by sensors in the head
Both TFD/FVS	Either TFD or FVS system triggers
Revolution Alarm	Revolution count set point has been achieved

## 10.1 Control and Status Mapping for Industrial Protocols

### Output Data ( PLC to Pump) - Pump Control

Offset Name	Description
0 - 1 Motor Percent Speed	Up to 2 decimal places, with most significant Offset representing the whole number and least significant Offset representing the decimal number. (Eg. 50.15 => MSB = 50, LSB = 15)
2 Motor Direction	0 = Clockwise, 1 = Counter-clockwise.
3 Prime	Prime pump or run motor at 100% for 60 seconds. 0 = deactivate prime, 1 = activated prime.
4 Reset Alarms	Reset alarms (TFD, FVS) on the pump. 0 = nothing, 1 = reset alarms. Only reset on a 0 -> 1 transition
5 Reset Tube Stats	Reset tube revolutions counter and hours ran
6 Cyclic Counter Direction	Cyclic counter direction (debugging purpose only). 0 = count up, 1 = count down
7 Cyclic Counter Speed	Cyclic counter speed (debugging purpose only). 0 = counter not incremented/decremented. Values > 0 = number of cycles it takes to increment/decrement the counter by one

### Input Data ( Pump to PLC) - Pump Status

Offset Name	Description
0 Prime Status	0 = Deactivated, 1 = Activated
1 Cover Status	0 = Cover Attached, 1 = Cover Detached
2 Motor Direction	0 = Clockwise, 1 = Counter-clockwise
3 TFD status	0 = No TFD alarm, 1 = TFD alarm
4 FVS status	0 = No FVS alarm, 1 = FVS alarm
5 Relay Output	Relay output statuses represented by each bit, where 0 = not triggered, and 1 = triggered. Bit 0 = Dry Contact 1, Bit 1 = Dry Contact 2, Bit 3 = Dry Contact 3, Bit 4 = Standard Relay
6 - 7 4-20 mA Output	Range: 400 - 2000 mA, where MSB represents the whole number and LSB represents the decimal number. Eg. 4.50 mA => Offset 6 = 4, Offset 7 = 50
8 - 9 Frequency Output	Range: 0 - 1000 Hz
10 - 11 Motor Percent Speed	Up to 2 decimal places, with most significant Offset representing the whole number and least significant Offset representing the decimal number. (Eg. 50.15 => MSB = 50, LSB = 15)
12 - 15 Firmware Version	Firmware version in semantic versioning format. Channel can be one of three values: 0 = stable, a(0x61) = alpha, b(0x62) = beta. Example: (1.0.5-beta => Offset 15: 1, Offset 14: 0, Offset 13: 5, Offset 12: b(0x62))
16 - 19 Tube Revolutions	Current tube revolution counter
20 - 23 Tube Hours	Number of hours ran for current tube
24 - 25 Cyclic Counter	Cyclic counter (debugging purpose only)

## 10.2 Control and Status Mapping for ModBus TCP

### Holding Registers (PLC to Pump) - Pump Control

Modbus Data Address	Name	Description
0000 - 0001	Motor Percent Speed	Up to 2 decimal places, with most significant byte representing the whole number and least significant byte representing the decimal number. (Eg. 50.15 => MSB = 50, LSB = 15)
0002	Motor Direction	0x00 = Clockwise, 0x01 = Counter-clockwise.
0003	Prime	Prime pump or run motor at 100% for 60 seconds. 0x00 = deactivate prime, 0x01 = activated prime.
0004	Reset Alarms	Reset alarms (TFD, FVS) on the pump. 0x00 = nothing, 0x01 = reset alarms. Only reset on a 0 -> 1 transition
0005	Reset Tube Stats	Reset tube revolutions counter and hours ran
0006	Cyclic Counter Direction	Cyclic counter direction (debugging purpose only). 0 = count up, 1 = count down
0007	Cyclic Counter Speed	Cyclic counter speed (debugging purpose only). 0 = counter not incremented/decremented. Values > 0 = number of cycles it takes to increment/decrement the counter by one

### Input Registers (Pump to PLC) - Pump Status

Modbus Data Address	Name	Description
0000	Prime Status	0 = Deactivated, 1 = Activated
0001	Cover Status	0 = Cover Attached, 1 = Cover Detached
0002	Motor Direction	0 = Clockwise, 1 = Counter-clockwise
0003	TFD status	0 = No TFD alarm, 1 = TFD alarm
0004	FVS status	0 = No FVS alarm, 1 = FVS alarm
0005	Relay Output	Relay output statuses represented by each bit, where 0 = not triggered, and 1 = triggered. Bit 0 = Dry Contact 1, Bit 1 = Dry Contact 2, Bit 3 = Dry Contact 3, Bit 4 = Standard Relay
0006 - 0007	4-20 mA Output	Range: 400 - 2000 mA, where MSB represents the whole number and LSB represents the decimal number. Eg. 4.50 mA => Byte 6 = 4, Byte 7 = 50
0008 - 0009	Frequency Output	Range: 0 - 1000 Hz
000A - 000B	Motor Percent Speed	Up to 2 decimal places, with most significant byte representing the whole number and least significant byte representing the decimal number. (Eg. 50.15 => MSB = 50, LSB = 15)
000C - 000F	Firmware Version	Firmware version in semantic versioning format. Channel can be one of three values: 0 = stable, a(0x61) = alpha, b(0x62) = beta. Example: (1.0.5-beta => Byte 15: 1, Byte 14: 0, Byte 13: 5, Byte 12: b(0x62))
0010 - 0013	Tube Revolutions	Current tube revolution counter
0014 - 0017	Tube Hours	Number of hours ran for current tube
0018 - 0019	Cyclic Counter	Cyclic counter (debugging purpose only)

## 10.3 EtherNet/IP

This is used to configure the EtherNet/IP

Four values to be defined:

- 1) IP Address
  - 2) Subnet Mask
  - 3) Gateway
  - 4) Always On (Connection will remain active even when mode is inactive/OFF)
- 

### To Enable EtherNet/IP:

1



Open the **App Drawer**

2



Select **Industrial Protocols**

3



Select **EtherNet/IP**

4

Pump will go to home screen

5



Select **Settings** to input:

- IP Address
- Subnet Mask
- Gateway
- Always On

6

Confirm by pressing **Save**

## 10.4 Modbus TCP/IP

This is used to configure the Modbus TCP/IP

Three values to be defined:

- 1) IP Address
  - 2) Subnet Mask
  - 3) Gateway
  - 4) Always On (Connection will remain active even when mode is inactive/OFF)
- 

### To Enable Modbus TCP:

1



Open the **App Drawer**

2



Select **Industrial Protocols**

3



Select **Modbus TCP/IP**

4

Pump will go to home screen

5



Select **Settings** to input:

- IP Address
- Subnet Mask
- Gateway
- Always On

6

Confirm by pressing **Save**



## 10.5 Profibus

This is used to configure the Profibus

Three values to be defined:

- 1) IP Address
- 2) Subnet Mask
- 3) Gateway
- 4) Always On (Connection will remain active even when mode is inactive/OFF)

---

### To Enable Profibus:

1



Open the **App Drawer**

2



Select **Industrial Protocols**

3



Select **Profibus**

4

Pump will go to home screen

5



Select **Settings** to input:

- IP Address
- Subnet Mask
- Gateway
- Always On

6

Confirm by pressing **Save**

## 11.1 Tube Info

This feature will display information regarding the tubing within the pump including:

- Tube type
  - Tube installation date
  - Tube run time & revolutions
  - Current maximum tube flow rate
- 

### To View The Tube Info:

1

Tap on the **Tube Info** text in the top portion of the screen

2

Tube info will be displayed

3

Click “reset” to reset the tube hours and revolutions

## 11.2 Tube Calibration

This feature allows the user to calibrate the pump's indicated flow rate to the system

---

### To Calibrate Your Tube:

1

On the home screen select the **Calibration Icon**



2

Enter values:

- Pump Speed (RPM)
- Run Time (seconds)

3

Select **Start** to begin

4

Select **Start**

5

Enter the measured flow rate into the field

6

Confirm by selecting **Save**

## 12.1 Pump Name

This is to change the name of the pump that is displayed on the home screen.

---

To Input Pump Name:

1



Open the **App Drawer**

2



Open **Settings**

3



Open **System**

4

Select "**Pump Name**"

5

Enter desired **Pump Name**

6

Confirm by pressing **OK**

## 12.2 Unit of Volume

This is to change the units of volume that is displayed.

---

### To Input Units of Volume:

1



Open the **App Drawer**

2



Open **Settings**

3



Open **System**

4

Select **Unit of Volume**

5

Select desired **Units of Volume**

- Milliliters
- Ounces
- Liters
- Gallons

6

Confirm by pressing **OK**

## 12.3 Unit of Time

This will change the Unit of Time that is displayed for the flow rate

---

To Input Unit of Time:

1



Open the **App Drawer**

2



Open **Settings**

3



Open **System**

4

Select **Unit of Time**

5

Select **Desired Time**

- Minutes (mL & ounces only)
- Hours
- Days (Gallons only)

6

Confirm by pressing **OK**

## 12.4 Chemical Name

This is used to change the Chemical Name that is displayed on the home screen.

---

To Input a Chemical Name:

1



Open the **App Drawer**

2



Open **Settings**

3



Open **System**

4

Select "**Chemical Name**"

5

Enter desired **Chemical Name**

6

Confirm by pressing **OK**

## 12.5 Set Language

This setting is used to change the system language.

---

To Input a Language:

1



Open the **App Drawer**

2



Open **Settings**

3



Open **System**

4

Select **Locale**

5

Select **Desired Language**

- English
- Deutch
- Español
- Français
- Portugues

6

Confirm by pressing **OK**



## 12.6 Pump Rotation Direction

This setting is used to change the rotational direction of pump. In most applications, the tube will fail by developing a small leak in the outlet side (pressure side) of the tube assembly. By reversing the roller rotation, the wear point in the tube is moved to the opposite side to the pump tube assembly, increasing the life of the tube.

**Important!** Changing the rotational direction of the pump reverses the inlet & outlet sides.

---

### To Change The Direction Of The Pump Rotation

**1**   
Open the **App Drawer**

**2**   
Open **Settings**

**3**   
Open **System**

**4**  
Select **Pump Direction**

**5**  
Select **Desired Rotation**  
•Clockwise  
•Counter Clockwise

**6**  
Confirm by pressing **OK**

Disconnect power from the pump. Carefully purge any pressure in the discharge line of the pump. Disconnect the suction end tubing/piping and the discharge end tubing/piping from the pump head tubing.

**IMPORTANT!** Swap sides of the suction (inlet) and discharge (outlet) tubing/piping. There is no need to remove the pump head cover.

**NOTE:** The pump tube will form a natural U-shaped curve. Do not attempt to install the pump tube against the natural U-shape direction as damage to the tube can result.

## 12.7 System Time

This setting is used to change the local time that is displayed.

---

### To Input The System Time:

1



Select the **Time** in the upper right hand corner

2

Select **Desired Hour**

3

Select **Desired Minute**

4

Select **AM or PM**

5

Confirm by pressing **OK**

## 12.8 Passcode

This setting is used to enable/disable the passcode, adjust the passcode time out and set or change the User Passcode.

Default settings: Pump will lockout after 30 seconds

---

### To Input a Passcode:

1



Open the **App Drawer**

2



Open **Settings**

3

Open **Passcode**

4

Enable Passcode

5

Select **User Passcode** and create new a six digit code.

6

Confirm by pressing **Save**

## 12.9 Factory Reset

This setting is used to factory reset the pump. This will erase all of the configurations and restore the pump to its original configuration when it left Blue-White factory.

---

### To Conduct A Factory Reset:

1



Open the **App Drawer**

2



Open **Settings**

3



Open **System**

4

Select **Reset to Factory Defaults**

5

Confirm by pressing **Continue**

6

Pump will **Reboot** and run through the initial setup process

Lost password? Email [customerservice@blue-white.com](mailto:customerservice@blue-white.com) to have your password reset

## 13.1 SYSTEM INFORMATION

This is to view the System Information

Information to be displayed:

- Pump Name
- Chemical Name
- Firmware Version
- System Build
- Manufactured Data & Time
- Serial Number
- Model
- I/O Port Firmware Version
- Motor Firmware Version
- Industrial Protocol Firmware Version
- Lifetime Run Hours & Revolutions

---

**To View The System Information:**

1



Open the **App Drawer**

2



Select **System Information**

## 13.2 Firmware Update

To update the firmware for your pump you first need to download and install Blue-Central® which is available at:

<https://www.blue-white.com/resources/>

---

### To Update The System Firmware:

**1**

Plug pump into a computer via USB and open Blue-Central® program

**2**

Select firmware tab and select “Start Upgrade”

**3**

The firmware upgrade box will appear showing the progress of the install.

**4**

Once the install is complete select “Close” to exit screen.

**CAUTION**

Always wear protective clothing, face shield, safety glasses and gloves when working on or near your metering pump. Additional precautions should be taken depending on solution being pumped. Refer to MSDS precautions from your solution supplier.

### 14.1 Routine Inspection and Maintenance

The pump requires very little maintenance. However, the pump and all accessories should be checked weekly. This is especially important when pumping aggressive chemicals. Inspect all components for signs of leaking, swelling, cracking, discoloration or corrosion. Replace worn or damaged components immediately.

Cracking, crazing, discoloration and the like during first week of operation are signs of severe chemical attack. If this occurs, immediately remove chemical from pump. Determine which parts are being attacked and replace them with parts that have been manufactured using more suitable materials.

### 14.2 How to Clean and Lubricate the Pump

When changing the pump tube assembly, the pump head chamber, roller assembly and pump head cover should be wiped free of any dirt and debris.

100% silicon lubrication may be used on the roller assembly. Refer to [www.blue-white.com/resources/videos](http://www.blue-white.com/resources/videos) for roller assembly maintenance video instructions.

Periodically clean the back flow prevention check valve assembly, especially when injecting fluids that calcify such as sodium hypochlorite. These lime deposits and other build ups can clog the fitting, increasing the back pressure at the pump (reducing tube life) and interfering with check valve operation.

The motor does not require maintenance or lubrication.

### 14.3 Removing Pump Head and Tubing

The pump requires very little maintenance. However, the pump and all accessories should be checked weekly. This is especially important when pumping aggressive chemicals.

Remove the **Pump Head Cover** by unscrewing the four **Thumb Screws**. Pull out the **Pump Head Cover**.

The pump will detect that the **Pump Head Cover** is removed and enter MAINTENANCE MODE.

Rotor will rotate at a maximum of 6 RPM for your safety.

Pull out the suction side of **Tubing Assembly**.

Press the START button. While the rotor is rotating, pull out the old **Tube Assembly**.

**TIP!** Let the pump do the work for you. Just guide the tubing out between the two rollers located on the **Rotor**.

Press the STOP button at any time to stop the pump.

Pull out the suction line adapter from the Pump Head. Pull out the **Tubing Assembly** as the **Rotor** rotates around.

Stop the pump by pressing the STOP button.

Thoroughly clean the **Pump Head** and **Rotor**. The **Rotor** can be removed by pulling it straight out. After the cleaning process, push the **Rotor** back on the shaft. See the drawing above for proper assembly. Be sure the front and rear rotor spacers are in place. **IMPORTANT!** **Rotor** direction; the word "FRONT" on **Rotor** must face the front of the pump.



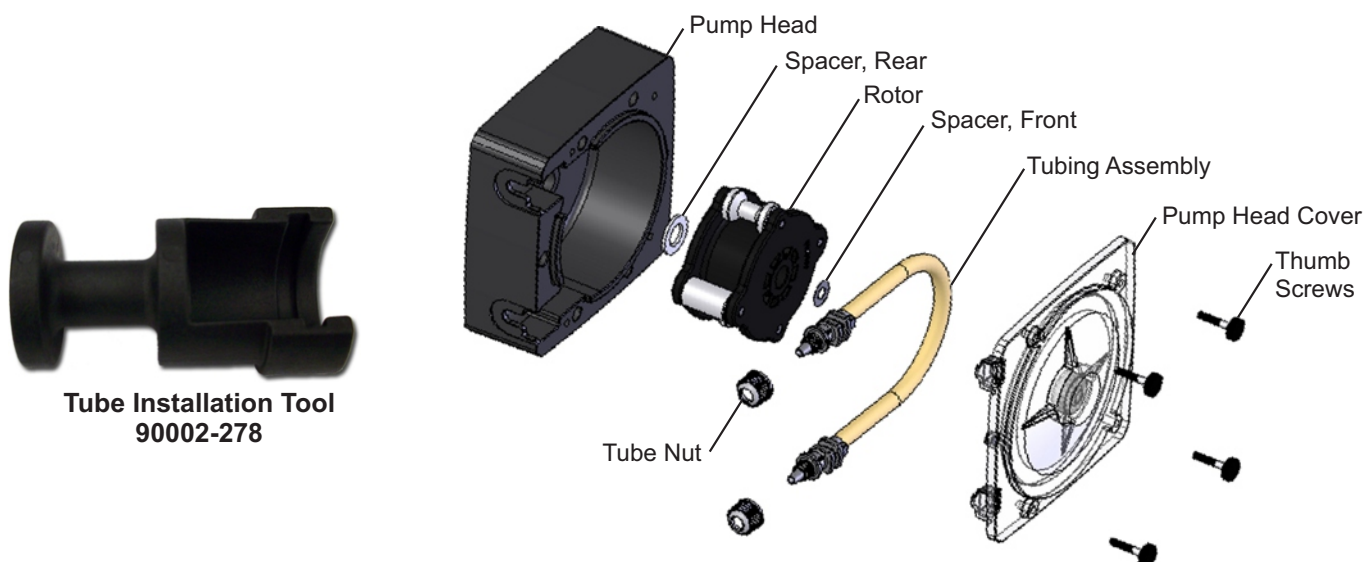

Locate your new tubing and Tube Installation Tool. See the next page to install new **Tube Assembly** into **Pump Head**.

### 14.4 Pump Head Exploded View





### 14.5 Tube Replacement

<b>CAUTION</b> 	Prior to service, pump clean water through the pump and suction / discharge line to remove chemical.
<b>CAUTION</b> 	Always wear protective clothing, face shield, safety glasses and gloves when working on or near your metering pump. Additional precautions should be taken depending on solution being pumped. Refer to MSDS precautions from your solution supplier.
<b>CAUTION</b> 	Use provided Tube Installation Tool to leverage tubing into pump head, <b>NOT YOUR FINGERS.</b>
<b>CAUTION</b> 	Use extreme caution when replacing pump tube. Be careful of your fingers and <b>DO NOT</b> place fingers near rollers.

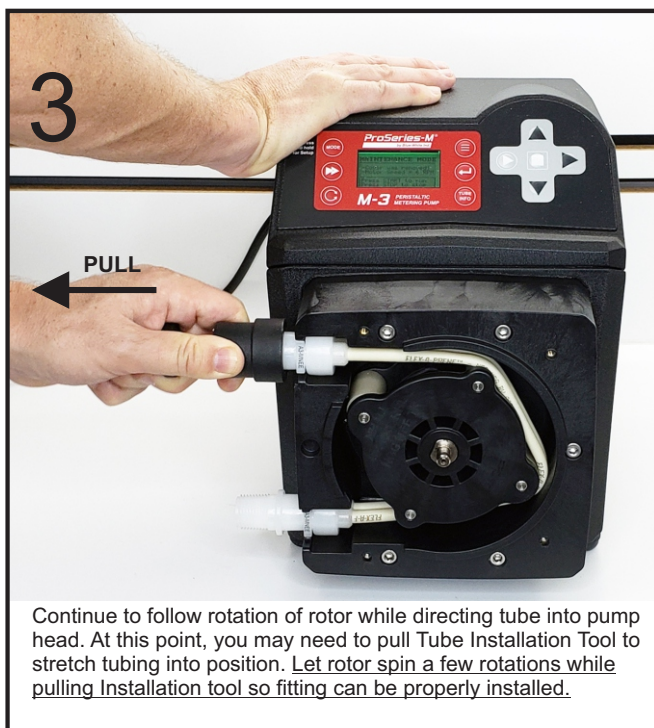
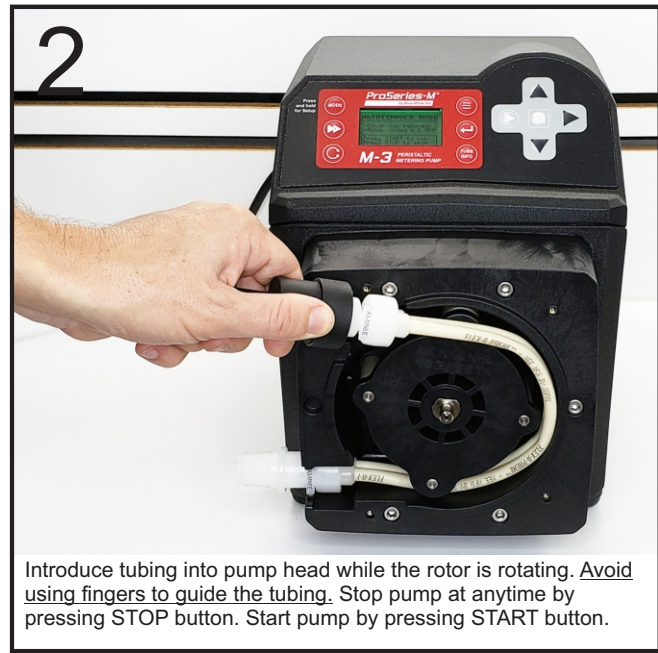
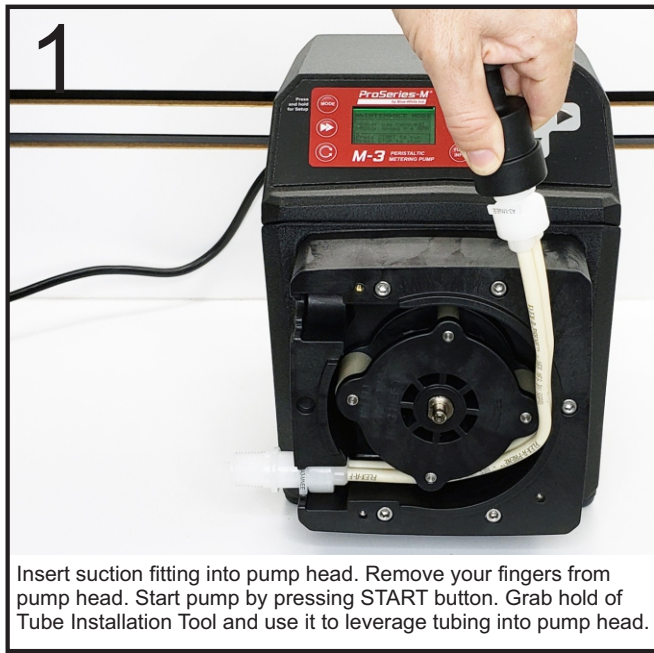

## 14.6 TFD

This pump is equipped with a Tube Failure Detecting System which is designed to stop the pump and provide an output alarm (see Output menu) in the event pump the tube should rupture and chemical enters the pump head.

This patented system is capable of detecting the presence of a large number of chemicals including Sodium Hypochlorite (Chlorine), Hydrochloric (muriatic) Acid, Sodium Hydroxide, and many others. The system will not be triggered by water (rain, condensation, etc.) or silicone oil (roller and tubing lubricant).

If a TFD alarm occurs, the pump will stop and the screen will turn red with “TFD”

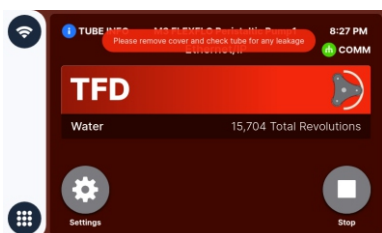

If TFD alarm occurs:

- 1 Remove the pump head cover, pump tube and roller assembly
- 2 Check for fluids at the bottom of the pump head
- 3 Carefully clean the chemical out of the pump head. Especially the sensor probes.
- 4 Replace the tubing
- 5 Reinstall only the pump head cover
- 6 Turn on the pump by pressing the START button
- 7 Reinstall the roller assembly and tubing.
- 8 Reinstall the pump head cover
- 9 Press the START button to clear the alarm condition

**PAGE INTENTIONALLY  
LEFT BLANK**

### 15.1 Replacement Parts

#### Pump Head Components

<b>1</b>	Spacer	90011-217	1
<b>2</b>	Complete Roller Assembly		1
	NL / NP	A4-MNL-R	
	TH / TK / TKL / THH	A4-MTH-R	
	NH / NK / NJ / NHH / NHL / NHHL	A4-MNH-R	
	NKL / NKKL	A4-MNKL-R	
	GH / GK / GKK	A4-MGH-R	
<b>3</b>	Tubing (Reference Tubing Matrix)		1
<b>4</b>	Pump Head Cover	A4-SXX-C	1
<b>5</b>	Thumb Screws	90011-183	8
<b>6</b>	Shaft Extension	90007-128	1

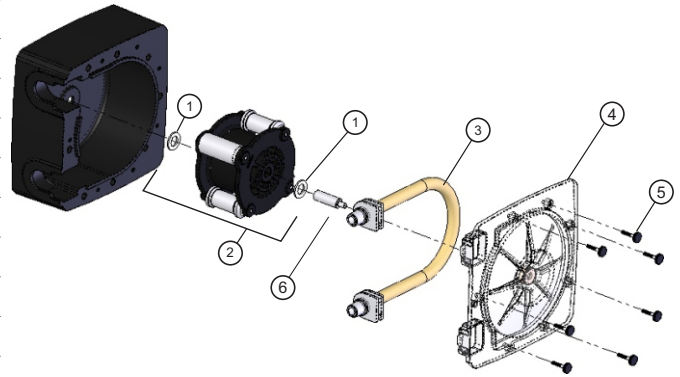

\*Pump Head not for sale. For more information please contact a local sales representative.

#### Roller Assembly Component Parts

<b>1</b>	A4 ROTOR BODY	90002-716	1
<b>2</b>	SPIDER RING	76002-038	1
<b>3</b>	10-32 CAPTIVE SCREW	90011-267	2
<b>4</b>	ARM ROLLER GUIDE ASSY	71010-771	2
<b>5*</b>	ARM ROLLER A4 NL / NP ASSY	71010-766	2
<b>5*</b>	ARM ROLLER A4 TH / TK / TKL / THH ASSY	71010-767	2
<b>5*</b>	ARM ROLLER A4 NH / NK / NJ / NHH / NHL / NHHL ASSY	71010-768	2
<b>5*</b>	ARM ROLLER A4 NKL / NKKL ASSY	71010-769	2

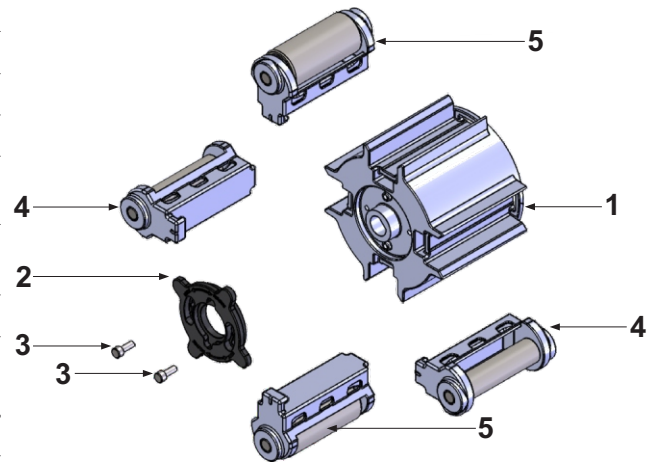

#### Quick Disconnect Fittings (only available for Q tubes)

<b>6</b>	Quick Disconnect Fittings		1
	.50" M/NPT FKM	KIT-QMV	1
	.50" M/NPT EP	KIT-QME	1
	.50" Barb FKM	KIT-QBV	1
	.50" Barb EP	KIT-QBE	1



#### Miscellaneous Parts (Sold Separately)

<b>A</b>	Stainless Steel Mounting Bracket	72000-379	1
<b>B</b>	Stainless Steel Mounting Bracket (Extended)	72000-380	1
<b>C</b>	Rubber Feet	90003-561	1
<b>D</b>	Tube Installation Tool	90002-278	1



**A**



**B**



**C**



**D**

## 15.2 Tube Matrix

### FLEXFLO® Model Number

<b>A4</b>	Tubing					
<b>Inlet/Outlet Connection Size, Connection Type, Connection Material</b>						
<b>M</b>	1/2" Male NPT Fitting, Natural PVDF (Kynar)					
<b>B</b>	1/2" ID Tubing Barb Fitting, Natural PVDF (Kynar)					
<b>Q</b>	Quick Disconnect, Natural PVDF (Kynar). NP flow rate reduced 16.5% with Quick Disconnect connections (Valves sold separately)					
<b>C</b>	1/2" - 3/4" Tri-clamp connections, Natural PVDF (Kynar)					
<b>MB</b>	1/2" Male BSPT Fitting, Natural PVDF (Kynar)					
<b>Pump Tube Material, Pump Tube Size</b>						
<b>GH</b>	Flex-A-Thane® .312 ID			<b>NKKL</b>	Flex-A-Prene® .500 ID (Dual Tube)	
<b>GHH</b>	Flex-A-Thane® .312 ID (Dual Tube)			<b>NKL</b>	Flex-A-Prene® .375 ID (max PSI 30)	
<b>GK</b>	Flex-A-Thane® .375 ID			<b>NL</b>	Flex-A-Prene® .500 ID	
<b>GKK</b>	Flex-A-Thane® .375 ID (Dual Tube)			<b>NP</b>	Flex-A-Prene® .750 ID	
<b>NH</b>	Flex-A-Prene® .250 ID			<b>TH</b>	Flex-A-Chem® .250 ID	
<b>NHL</b>	Flex-A-Prene® .250 ID (max PSI 65)			<b>NHHL</b>	Flex-A-Prene® .250 ID (Dual Tube) (max PSI 65)	
<b>NHH</b>	Flex-A-Prene® .250 ID (Dual Tube)			<b>TK</b>	Flex-A-Chem® .375 ID	
<b>NJ</b>	Flex-A-Prene® .312 ID			<b>TKK</b>	Flex-A-Chem® .375 ID (Dual Tube)	
<b>NK</b>	Flex-A-Prene® .375 ID					
<b>A4</b>	-	<b>M</b>	<b>NH</b>	-	<b>T</b>	Tube Sample Model Number

## Output Specifications

Tube Material / Size	Feed Rate			Max Speed	Max Pressure	Max Temperature
	GPH	LPH	mL/Min	RPM	PSI (bar)	°F (°C)
<b>Flex-A-Thane® Tube</b>						
GH	Up to 39.6	Up to 150	Up to 2500	125	65 (4.5)	130 (54)
GK	Up to 55.5	Up to 210	Up to 3500	125	65 (4.5)	130 (54)
GKK	Up to 100.0	Up to 378	Up to 6300	125	65 (4.5)	130 (54)
<b>Flex-A-Prene® Tube</b>						
NH	Up to 28.5	Up to 108	Up to 1800	125	125 (8.6)	185 (85)
NJ	Up to 44.4	Up to 168	Up to 2800	125	100 (6.9)	185 (85)
NHHL	Up to 54.4	Up to 204	Up to 3400	125	65 (4.5)	185 (85)
NK	Up to 50.7	Up to 192	Up to 3200	125	80 (5.5)	185 (85)
NHH	Up to 54.0	Up to 204	Up to 3400	125	100 (6.9)	185 (85)
NL	Up to 100.0	Up to 378	Up to 6300	125	50 (3.4)	185 (85)
NP**	Up to 158.5	Up to 600	Up to 10000	125	30 (2.1)	185 (85)
<b>Flex-A-Chem® Tube</b>						
TK	Up to 54.00	Up to 204	Up to 3400	125	30 (2.1)	130 (54)
TKK	Up to 126.0	Up to 477.0	Up to 8000	125	30 (2.1)	130 (54)

## 16.0 ACCESSORIES

The following accessories are available for the M4 FLEXFLO® Peristaltic Metering Pump. Please visit [Blue-white.com](http://Blue-white.com) for more information. All accessories are sold separately.



**KIT-M12**  
TWO M12 CABLES

\*KIT-M12-3 for 3 Cables

### KIT-M12

Kit contains: Two M12 cables.

KIT-M12 WIRING INSTRUCTIONS		
DIAGRAM	PIN #	WIRE COLOR
	PIN 1	BROWN
	PIN 2	WHITE
	PIN 3	BLUE
	PIN 4	BLACK
	PIN 5	GRAY

NOTE: THIS DIAGRAM IS FOR THE PUMP'S M12 PORT



**CABLE-UAC**  
USB A-C CABLE

### CABLE-UAC

Kit contains: One 3' USB-A to USB-C cable.



**KIT-PB3**  
One 3ft Profibus Cable

### KIT-DP3

Kit contains: One 3' profibus cable.



**KIT-QMV**  
.50" M/NPT QUICK CONNECT

\*KIT-QME for EP O-rings

### KIT-QMV

Kit contains: One Quick Connect Inlet with .50" M/NPT (assembled with FKM O-rings) and One Quick Connect Outlet with .50" M/NPT (assembled with FKM O-rings)



**KIT-QBV**  
.50" BARB QUICK CONNECT

### KIT-QBV

Kit contains: One Quick Connect Inlet with .50" hose barb connection (assembled with FKM O-rings), One Quick Connect Inlet with .50" hose barb connection (assembled with FKM O-rings) and two #5 Clamps.



**KIT-MVM**

Kit contains: One Tube Install Tool, One Foot Strainer, One injection valve

**KIT-MTVB**

Kit contains: 10ft Suction Tube, 10ft Discharge tube, One Tube Install Tool, One Injector fitting, One Foot Strainer, and Two Stainless Steel Clamps #5

**PAGE INTENTIONALLY  
LEFT BLANK**



## 17.0 WARRANTY

### 17.1 LIMITED WARRANTY

Your new FLEXFLO pump is a quality product and is warranted for 60 months from date of purchase (proof of purchase is required). The pump will be repaired or replaced at our discretion. Failure must have occurred due to defect in material or workmanship and not as a result of operation of the product other than in normal operation as defined in the pump manual. Warranty status is determined by the pump's serial label and the sales invoice or receipt. The serial label must be on the pump and legible. The warranty status of the pump will be verified by Blue-White or a factory authorized service center.

Pump Head and roller assembly is warranted against damage from chemical attack when proper TFD (Tube Failure Detection) system instructions and maintenance procedures are followed.

### 17.2 WHAT IS NOT COVERED

- Pump Tube Assemblies and rubber components – They are perishable and require periodic replacement.
- Pump removal, or re-installation, and any related labor charge.
- Freight to the factory, or service center.
- Pumps that have been tampered with, or in pieces.
- Damage to the pump that results from misuse, carelessness such as chemical spills on the enclosure, abuse, lack of maintenance, or alteration which is out of our control.
- Pumps damaged by faulty wiring, power surges or acts of nature.

### 17.3 PROCEDURE FOR IN WARRANTY REPAIR

Contact the factory to obtain a RMA (Return Material Authorization) number. Carefully pack the pump to be repaired. It is recommended to include foot strainer and injection/check valve fitting since these devices may be clogged and part of the problem. Please enclose a brief description of the problem as well as the original invoice or sales receipt, or copy showing the date of purchase. Prepay all shipping costs. COD shipments will not be accepted. Warranty service must be performed by the factory or an authorized service center. Damage caused by improper packaging is the responsibility of the sender. When In-Warranty repair or replacement is completed, the factory pays for return shipping to the dealer or customer.

### 17.4 PRODUCT USE WARNING

Blue-White products are manufactured to meet the highest quality standards in the industry. Each product instruction manual includes a description of the associated product warranty and provides the user with important safety information. Purchasers, installers, and operators of Blue-White products should take the time to inform themselves about the safe operation of these products. In addition, Customers are expected to do their own due diligence regarding which products and materials are best suited for their intended applications. Blue-White is pleased to assist in this effort but does not guarantee the suitability of any particular product for any specific application as Blue-White does not have the same degree of familiarity with the application that the customer/end user has. While Blue-White will honor all of its product warranties according to their terms and conditions, Blue-White shall only be obligated to repair or replace its defective parts or products in accordance with the associated product warranties. **BLUE-WHITE SHALL NOT BE LIABLE EITHER IN TORT OR IN CONTRACT FOR ANY LOSS OR DAMAGE WHETHER DIRECT, INDIRECT, INCIDENTAL, OR CONSEQUENTIAL, ARISING OUT OF OR RELATED TO THE FAILURE OF ANY OF ITS PARTS OR PRODUCTS OR OF THEIR NONSUITABILITY FOR A GIVEN PURPOSE OR APPLICATION.**

### 17.5 CHEMICAL RESISTANCE WARNING

Blue-White offers a wide variety of wetted parts. Purchasers, installers, and operators of Blue-White products must be well informed and aware of the precautions to be taken when injecting or measuring various chemicals, especially those considered to be irritants, contaminants or hazardous. Customers are expected to do their own due diligence regarding which products and materials are best suited for their applications, particularly as it may relate to the potential effects of certain chemicals on Blue-White products and the potential for adverse chemical interactions. Blue-White tests its products with water only. The chemical resistance information included in this instruction manual was supplied to Blue-White by reputable sources, but Blue-White is not able to vouch for the accuracy or completeness thereof. While Blue-White will honor all of its product warranties according to their terms and conditions, Blue-White shall only be obligated to repair or replace its defective parts or products in accordance with the associated product warranties. **BLUE-WHITE SHALL NOT BE LIABLE EITHER IN TORT OR IN CONTRACT FOR ANY LOSS OR DAMAGE, WHETHER DIRECT, INDIRECT, INCIDENTAL, OR CONSEQUENTIAL, ARISING OUT OF OR RELATED TO THE USE OF CHEMICALS IN CONNECTION WITH ANY BLUE-WHITE PRODUCTS.**

**APPENDIX A: ACRONYMS**

°C	Celsius	RMA	Return Material Authorization
°F	Fahrenheit	RPM	Revolutions per minute
AC	Alternating current	SIP	Steam-in-place
bar	Unit of pressure	SS	Solid state
CIP	Clean-in-place	TFD+	Enhanced Tube Failure Detection
cm	Centimeters	TFE/P	Tetrafluoroethylene propylene
COD	Cash on Delivery	UL	Underwriters Laboratories
D	Depth	US	United States
DC	Direct current	V	Volt
EEE	Electrical and electronic equipment	W	Watt
EP	Ethylene propylene	W	Width
ETL	Electrical Testing Labs/Intertek	WEEE	Waste Electrical and Electronic Equipment
EU	European Union		
FDA	Food and Drug Administration		
FKM	Fluoroelastomer		
FVS	Flow Verification Sensor		
GF	Glass fiber		
GPD	Gallons per day		
GPH	Gallons per hour		
H	Height		
Hz	Hertz		
ID	Inside diameter		
IO	Input/Output		
Kg	Kilogram		
lb.	Pound		
LLDPE	Linear low-density polyethylene		
LPH	Liters per hour		
mA	Milliampere		
min	Minute		
mL	Milliliters		
MSDS	Material Safety Data Sheet		
N.C.	Normally Close		
N.O.	Normally Open		
NPT	National Pipe Thread		
NSF	National Sanitation Foundation		
OD	Outside diameter		
P.N.	Part Number		
PBT	Polybutylene Terephthalate		
PE	Polyethylene		
PSI	Pounds per Square Inch		
PVC	Polyvinyl chloride		
PVDF	Polyvinylidene fluoride		
RCD	Residual-current device		
Rev.	Revision		

**FLEXFLO® Model Number**

**M4** FLEXFLO® Peristaltic metering pump

**Power Cord (operating voltage user selectable 115V/240 VAC 50/60Hz)**

<b>4</b>	115V / 60Hz, power cord NEMA 5/15 plug (US)	<b>8</b>	240V / 50Hz, power cord AS 3112 plug (AU/New Zealand)
<b>5</b>	230V / 60Hz, power cord NEMA 6/15 plug (US)	<b>9</b>	230V / 50Hz, power cord BS 1363/A plug (UK)
<b>6</b>	220V / 50Hz, power cord CEE 7/VII plug (EU)	<b>X</b>	No Power Cord

**Inlet/Outlet Connection Size, Connection Type, Connection Material**

<b>M</b>	1/2" Male NPT Fitting, Natural PVDF (Kynar)	<b>Q</b>	Quick Disconnect, Natural PVDF (Kynar), available for all tubes (valves sold separately)
<b>B</b>	1/2" Hose Barb, Natural PVDF (Kynar) available for all tubes	<b>MB</b>	1/2" Male BSPT Fitting, Natural PVDF (Kynar)
<b>C</b>	1/2" - 3/4" Tri-clamp connections, Natural PVDF (Kynar), available for all tubes		

**Pump Tube Material, Pump Tube Size, Output Range**

<b>NH</b>	Flex-A-Prene® .250 ID	<b>NKL</b>	Flex-A-Prene® .375 ID	<b>GK</b>	Flex-A-Thane® .375 ID
<b>NHH</b>	Flex-A-Prene® .250 ID (dual tube)	<b>NL</b>	Flex-A-Prene® .500 ID	<b>GKK</b>	Flex-A-Thane® .375 ID (dual tube)
<b>NHHL</b>	Flex-A-Thane® .250 ID (dual tube)	<b>NP</b>	Flex-A-Prene® .750 ID	<b>TH</b>	Flex-A-Chem® .250 ID
<b>NHL</b>	Flex-A-Prene® .250 ID	<b>GH</b>	Flex-A-Thane® .312 ID	<b>TK</b>	Flex-A-Chem® .375 ID
<b>NJ</b>	Flex-A-Prene® .312 ID	<b>GHH</b>	Flex-A-Thane® .312 ID (dual tube)	<b>TKK</b>	Flex-A-Chem® .375 ID (dual tube)
<b>NK</b>	Flex-A-Prene® .375 ID				

**Options** (leave this blank for standard model with left facing pump head inlet/outlet)

<b>R</b>	Right facing pump head, input / output (Left facing fluid input / output is standard)
<b>D</b>	Down facing pump head, input / output (Left facing fluid input / output is standard)

**M4** **S** **2** **4** **-** **M** **NH** **R** **Sample Model Number**

**Accessories**

**NOTE:** For use with the Quick Disconnect Tube Assembly. Kits sold separately.

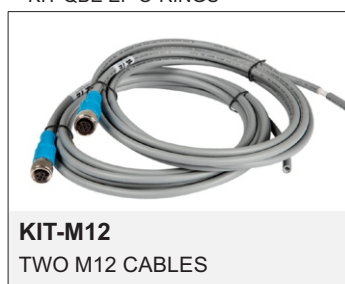

**NOTE:** Accessories sold separately.



Users of electrical and electronic equipment (EEE) with the WEEE marking per Annex IV of the WEEE Directive must not dispose of end of life EEE as unsorted municipal waste, but use the collection framework available to them for the return, recycle, recovery of WEEE and minimize any potential effects of EEE on the environment and human health due to the presence of hazardous substances. The WEEE marking applies only to countries within the European Union (EU) and Norway. Appliances are labeled in accordance with European Directive 2002/96/EC.

Contact your local waste recovery agency for a *Designated Collection Facility* in your area.

**Blue-White**<sup>®</sup>

5300 Business Drive  
Huntington Beach, CA 92649  
USA

TEL: 714-893-8529  
FAX: 714-894-9492

[www.blue-white.com](http://www.blue-white.com)  
[sales@blue-white.com](mailto:sales@blue-white.com)  
[customerservice@blue-white.com](mailto:customerservice@blue-white.com)