

## SERIES C2F / C3F

Operating Manual



**ProSeries**<sup>®</sup>  
by Blue-White Ind.

5300 Business Drive, Huntington Beach, CA 92649 USA

Phone: 714-893-8529 FAX: 714-894-9492

E mail: [sales@blue-white.com](mailto:sales@blue-white.com) | [techsupport@blue-white.com](mailto:techsupport@blue-white.com) URL: [www.Blue-White.com](http://www.Blue-White.com)

|             |   |           |
|-------------|---|-----------|
| <b>1.0</b>  | <b>Introduction</b>                             | <b>3</b>  |
|             | 1.1 Available Models                            |           |
| <b>2.0</b>  | <b>Specifications</b>                           | <b>4</b>  |
|             | 2.1 Materials of Construction                   |           |
| <b>3.0</b>  | <b>Features</b>                                 | <b>5</b>  |
|             | 3.1 Agency Listings                             | 5         |
| <b>4.0</b>  | <b>Installation</b>                             | <b>6</b>  |
|             | 4.1 Mounting Location                           | 6         |
|             | 4.2 Dimensions                                  | 6         |
|             | 4.3 Installation Injection Fitting and Strainer | 7         |
| <b>5.0</b>  | <b>Power Connections</b>                        | <b>8</b>  |
|             | 5.1 Wiring Terminal and I/O Schematics          | 9         |
| <b>6.0</b>  | <b>How to Operate Chem-Pro - Control Pad</b>    | <b>10</b> |
| <b>7.0</b>  | <b>Set Remote Start/Stop</b>                    | <b>11</b> |
|             | 7.1 Set FVS (Flow Verification Sensor)          | 12        |
| <b>8.0</b>  | <b>Manual Operation</b>                         | <b>14</b> |
| <b>9.0</b>  | <b>DFD (Diaphragm Failure Detection)</b>        | <b>15</b> |
| <b>10.0</b> | <b>Alarm Relay</b>                              | <b>16</b> |
| <b>11.0</b> | <b>Volumetric Test - Calibration</b>            | <b>16</b> |
| <b>12.0</b> | <b>Pump Maintenance</b>                         | <b>17</b> |
|             | 12.1 Routine Inspection and Maintenance         | 17        |
|             | 12.2 Cleaning Pump                              | 17        |
|             | 12.3 Motor Brush Replacement                    | 18        |
| <b>13.0</b> | <b>Output Versus Pressure</b>                   | <b>19</b> |
|             | 13.1 C2 Output Versus Pressure                  | 19        |
|             | 13.2 C3 Output Versus Pressure                  | 19        |
| <b>14.0</b> | <b>Replacement Parts List</b>                   | <b>20</b> |
|             | 14.1 C2 Parts List                              | 20        |
|             | 14.2 C3 Parts List                              | 21        |
|             | Typical Installation                            | 22        |
|             | <b>Warranty</b>                                 | <b>23</b> |

PLEASE READ ENTIRE INSTRUCTION MANUAL PRIOR TO INSTALLATION AND USE.

## 1.0 Introduction

Congratulations on purchasing Chem-Pro® variable speed Diaphragm Metering Pump. A diaphragm pump is a type of positive displacement pump used for pumping a variety of fluids.

Your Chem-Pro® pump is pre-configured for diaphragm, pump head and fittings that shipped with your metering pump.

**Please Note:** Your new pump has been pressure tested at the factory with clean water before shipping. You may notice trace amounts of clean water in pump head. This is part of our stringent quality assurance program at Blue-White Industries.

## 1.1 Available Models

| <b>C2F Diaphragm Metering Pump</b> |             |               |                     |                             | <b>Max. 166 Strokes Per Minute</b> |                |                |
|------------------------------------|-------------|---------------|---------------------|-----------------------------|------------------------------------|----------------|----------------|
| <b>No Metal in fluid path</b>      |             |               |                     |                             |                                    |                |                |
| <b>Feed Rate at 0 PSIG</b>         |             |               | <b>Max Pressure</b> | <b>Connection Type</b>      | <b>C2F Model Numbers</b>           |                |                |
| <b>GPH</b>                         | <b>LPH</b>  | <b>ML/Min</b> | <b>PSIG (bar)</b>   | <b>Fittings</b>             | <b>115V AC</b>                     | <b>230V AC</b> | <b>220V AC</b> |
| .067 - 6.7                         | .254 - 25.4 | 4.23 - 423    | 175 (12)            | 1/2" Male NPT / PVDF        | C2F243XVA                          | C2F253XVA      | C2F263XVA      |
| .067 - 6.7                         | .254 - 25.4 | 4.23 - 423    | 175 (12)            | 1/2" Female NPT / PVDF      | C2F243XVB                          | C2F253XVB      | C2F263XVB      |
| .067 - 6.7                         | .254 - 25.4 | 4.23 - 423    | 175 (12)            | 1/2" Hose Barb / PVDF       | C2F243XVC                          | C2F253XVC      | C2F263XVC      |
| .067 - 6.7                         | .254 - 25.4 | 4.23 - 423    | 175 (12)            | 3/8" Tube compression/ PVDF | C2F243XVD                          | C2F253XVD      | C2F263XVD      |
| .10 - 10                           | .38 - 38    | 6.31 - 631    | 175 (12)            | 1/2" Male NPT / PVDF        | C2F241XVA                          | C2F251XVA      | C2F261XVA      |
| .10 - 10                           | .38 - 38    | 6.31 - 631    | 175 (12)            | 1/2" Female NPT / PVDF      | C2F241XVB                          | C2F251XVB      | C2F261XVB      |
| .10 - 10                           | .38 - 38    | 6.31 - 631    | 175 (12)            | 1/2" Hose Barb / PVDF       | C2F241XVC                          | C2F251XVC      | C2F261XVC      |
| .10 - 10                           | .38 - 38    | 6.31 - 631    | 175 (12)            | 3/8" Tube compression/ PVDF | C2F241XVD                          | C2F251XVD      | C2F261XVD      |
| .165 - 16.5                        | .625 - 62.5 | 10.41 - 1041  | 175 (12)            | 1/2" Male NPT / PVDF        | C2F242XVA                          | C2F252XVA      | C2F262XVA      |
| .165 - 16.5                        | .625 - 62.5 | 10.41 - 1041  | 175 (12)            | 1/2" Female NPT / PVDF      | C2F242XVB                          | C2F252XVB      | C2F262XVB      |
| .165 - 16.5                        | .625 - 62.5 | 10.41 - 1041  | 175 (12)            | 1/2" Hose Barb / PVDF       | C2F242XVC                          | C2F252XVC      | C2F262XVC      |
| .165 - 16.5                        | .625 - 62.5 | 10.41 - 1041  | 175 (12)            | 3/8" Tube compression/ PVDF | C2F242XVD                          | C2F252XVD      | C2F262XVD      |

| <b>C3F Diaphragm Metering Pump</b> |            |               |                     |                        | <b>Max. 130 Strokes Per Minute</b> |                |                |
|------------------------------------|------------|---------------|---------------------|------------------------|------------------------------------|----------------|----------------|
| <b>No Metal in fluid path</b>      |            |               |                     |                        |                                    |                |                |
| <b>Feed Rate at 0 PSIG</b>         |            |               | <b>Max Pressure</b> | <b>Connection Type</b> | <b>C3F Model Numbers</b>           |                |                |
| <b>GPH</b>                         | <b>LPH</b> | <b>ML/Min</b> | <b>PSIG / bar</b>   | <b>Fittings</b>        | <b>115V AC</b>                     | <b>230V AC</b> | <b>220V AC</b> |
| .262 - 26.2                        | .99 - 99   | 16.50 - 1650  | 150 / 10.3          | 1/2" Male NPT / PVDF   | C3F241XVA                          | C3F251XVA      | C3F261XVA      |
| .262 - 26.2                        | .99 - 99   | 16.50 - 1650  | 150 / 10.3          | 1/2" Female NPT / PVDF | C3F241XVB                          | C3F251XVB      | C3F261XVB      |
| .262 - 26.2                        | .99 - 99   | 16.50 - 1650  | 150 / 10.3          | 1/2" Hose Barb / PVDF  | C3F241XVC                          | C3F251XVC      | C3F261XVC      |
| .406 - 40.6                        | 1.54 - 154 | 25.60 - 2560  | 100 / 6.8           | 1/2" Male NPT / PVDF   | C3F242XVA                          | C3F252XVA      | C3F262XVA      |
| .406 - 40.6                        | 1.54 - 154 | 25.60 - 2560  | 100 / 6.8           | 1/2" Female NPT / PVDF | C3F242XVB                          | C3F252XVB      | C3F262XVB      |
| .406 - 40.6                        | 1.54 - 154 | 25.60 - 2560  | 100 / 6.8           | 1/2" Hose Barb / PVDF  | C3F242XVC                          | C3F252XVC      | C3F262XVC      |

•Chem-Pro® Pumps motor speed is linear over the entire 1% to 100% adjustment range.

•Output versus pressure is nearly linear in all models.

•Feed rates taken in laboratory environment with clean water after 20 minute diaphragm break-in period with a 3 foot (1 meter) suction lift.

### Optional Extended Brackets

Stainless Steel extended brackets allow pump to be securely mounted to most any surface; floor, shelf, or skid. Brackets lift pump up 4-1/2 inches (11.43 cm), for easy pump access in hard to reach areas.

- Raise metering pump 4-1/2 inches (11.43 cm) off ground or a surface.
- Made out of tough Stainless Steel.
- Provides a stable mounting surface.

| <b>Model #</b> | <b>Description</b>                                 |
|----------------|--|
| 72000-380      | Extended Mounting Bracket, 1 Pair, SS, 4 SS Screws |



## 2.0 Specifications

### Maximum working pressure\*:

175 psig (12 bar), \*model specific  
Note: see individual pump model maximum pressure ratings.

### Maximum Fluid temperature (excluding pump tubes):

130° F (54° C)  
Note: see individual pump tube assembly maximum temperature ratings.

### Maximum fluid viscosity:

1,000 Centipoise

### Maximum suction lift:

15 ft. Water, 0 psig (4.5 m, 0 bar)

### Ambient Operating Temperature

14°F to 115°F (-10°C to 46°C)

### Ambient Storage Temperature

-40°F to 158°F (-40°C to 70°C)

### Operating Voltage:

115VAC/60Hz, 1ph (1.5 Amp Maximum)  
230VAC/60Hz, 1ph (0.7 Amp Maximum)  
220VAC/50Hz, 1ph (1.0 Amp Maximum)  
240VAC/50Hz, 1ph (1.0 Amp Maximum)

### Power Cord Options:

115V60Hz = NEMA 5/15 (USA)  
230V60Hz = NEMA 6/15 (USA)  
220V50Hz = CEE 7/VII (EU)  
240V50Hz = AS 3112 (Australia/New Zealand)

### Motor:

Brushed DC, 1/8 H.P.

### Duty cycle:

Continuous

### Motor speed adjustment range 100:1:

1.0% - 100% motor speed (1.3 to 130 RPM)

### Motor speed adjustment resolution:

0.1% increments

### Accuracy:

+/- 2% of full scale  
Repeatability +/- 0.5%

### Display

Backlit LCD, UV resistant.

### Keypad

Four button positive action tactile switch keypad.

### Enclosure:

NEMA 4X (IP66), Powder coated aluminum.  
Maximum overall dimensions:  
C2 models: 11-3/4"W x 7-3/4"H x 10-3/4"D (298W x 197H x 274D mm)  
C3 models: 13-1/8"W x 9"H x 10-3/4"D (333W x 228H x 274D mm)

### Approximate shipping wt:

C2 models: 24 lb. (10.9 Kg)  
C3 models: 29 lb. (13.1 Kg)

## 2.1 Materials of construction

### Wetted components:

#### Pump Head Assembly:

Pump Head: .....PVDF  
Adapter Connections: .....PVDF  
Valve Cartridges: .....PVDF  
Valve Balls: .....Ceramic  
Valve Ball Seats: .....TFE/P  
Tetrafluorethylene/propylene  
Static Seals: .....TFE/P (optional EP)  
Diaphragm: .....PVDF, Flex-A-Prene®

#### Injection / Back-flow Check valve:

Body & insert: .....PVDF  
Check Ball: .....Ceramic  
Spring: .....Hastelloy C-276  
O-ring seals: .....TFE/P (optional EP)

#### Foot Valve / Strainer:

Body & Adapter: .....PVDF  
Check Ball: .....Ceramic  
Spring: .....Hastelloy C-276  
O-ring seals: .....TFE/P (optional EP)  
Filter screen: .....PVDF

Suction Tubing: .....Clear PVC (if supplied)

#### Discharge Tubing

3/4" x 1/2" Tube connections: ....Not supplied  
1/4" x 3/8" Tube connections: ....Natural Polyethylene (LLDPE)

### Non-Wetted components:

#### Enclosure:

413 Aluminum (Polyester powder coated)

#### Pump Head Cover:

413 Aluminum (Polyester powder coated)

#### Cover Screws:

300 Series Stainless Steel

#### DFD System Sensor pins:

Hastelloy C-276

#### Power Cord:

3 conductor, SJTW-A Water-resistant

#### Mounting Brackets and Hardware:

316 Series Stainless Steel

### 3.0 Features

Motor driven diaphragm pump offers smooth and quiet chemical dosing. No hard pulses as seen with solenoid driven pumps.

Full stroke every time avoids vapor lock.

Variable speed DC motor.

Rated for continuous duty (24X7).

PVDF / PTFE / Ceramic pump head components.

Diaphragm Failure Detection (DFD) system. Senses diaphragm failure by detecting chemical in pump head.

Backlit LCD displays motor speed, input signal values, service and alarm status.

CNC precision machined cam and piston for optimum efficiency, unparalleled accuracy, and linearity.

Heavy duty PVDF pump head and valves are standard.

Compatible with Blue-White's output Flow Verification Sensor (FVS) system.

### 3.1 Agency Listings



This pump is ETL listed to conform to the following:  
UL Standard 778 as a motor operated water pump  
CSA Standard C22.2 as process control equipment



This pump complies to the Machinery Directive 98/37/EC, BS EN 60204-1, Low Voltage Directive 73/23/EC BS EN 61010-1, EMC Directive 89/336/EC, BS EN 50081-1/BS EN 50082-1.

| Symbol | Explanation                           |
|--------|---------------------------------------|
|        | WARNING, risk of electric shock       |
|        | CAUTION, refer to users' guide        |
|        | GROUND, PROTECTIVE CONDUCTOR TERMINAL |

#### Enclosure Rating:

**NEMA 4X:** Constructed for either indoor or outdoor use to provide a degree of protection to personnel against incidental contact with enclosed equipment; to provide a degree of protection against falling dirt, rain, sleet, snow, windblown dust, splashing water, and hose-directed water; and that will be undamaged by external formation of ice on enclosure.

**IP66:** No ingress of dust; complete protection against contact. Water projected in powerful jets against enclosure from any direction shall have no harmful effects.

## 4.0 Installation

|                     |   |
|---------------------|---|
| <b>CAUTION</b><br>⚠ | Risk of chemical overdose. Be certain pump does not overdose chemical during backwash and periods of no flow in circulation system.   |
| <b>CAUTION</b><br>⚠ | Always wear protective clothing, face shield, safety glasses and gloves when working on or near your metering pump. Additional precautions should be taken depending on solution being pumped. Refer to MSDS precautions from your solution supplier. |
| <b>CAUTION</b><br>⚠ | All diagrams are strictly for guideline purposes only. Always consult an expert before installing metering pump on specialized systems. Metering pump should be serviced by qualified persons only.   |

### 4.1 Mounting Location

Choose an area located near chemical supply tank, chemical injection point, and electrical supply. Install pump where it can be easily serviced.

316SS Mounting brackets are included. Mount pump to a secure surface using enclosed mounting hardware.

Mount pump close to injection point. Keep inlet (suction) and outlet (discharge) tubing as short as possible. Longer discharge tubing increases back pressure at pump head.

**Important!** Install a back flow prevention check valve at discharge side of pump to prevent system fluid from flowing back through pump during pump maintenance. **Important!**

A pressure relief valve is recommended at discharge of pump.

### 4.2 Dimensions

The image contains three technical drawings of the metering pump. The 'Top' view shows dimensions A (width), B (height), C (depth), and D (mounting bracket height). The 'Front' view shows dimensions E (width), F (height), G (total height with bracket), and I (width to center). The 'Right' view shows dimensions F (height) and J (width).

| C2 Dimensions |        |      | C3 Dimensions |        |      |
|---------------|--------|------|---------------|--------|------|
| Dim           | Inches | cm   | Dim           | Inches | cm   |
| A             | 14.1"  | 32.5 | A             | 14.1"  | 35.8 |
| B             | 11.5"  | 29.2 | B             | 12"    | 30.5 |
| C             | 3.7"   | 9.5  | C             | 3.7"   | 9.5  |
| D             | 2.5"   | 6.4  | D             | 2.5"   | 6.4  |
| E             | 13.1"  | 29.9 | E             | 13.1"  | 33.2 |
| F             | 7.9"   | 20.1 | F             | 9"     | 22.9 |
| G             | 7.3"   | 18.4 | G             | 7.8"   | 19.8 |
| H             | 6.5"   | 16.4 | H             | 6.5"   | 16.4 |
| I             | 15"    | 34.6 | I             | 15"    | 38   |
| J             | 8"     | 20.3 | J             | 8"     | 20.3 |

**Note:** Optional Extended Bracket adds 4.5" (11.43cm) to overall height (dimension G and H). See page 3 for details.

### 4.3 Installing Injection Fitting and Strainer

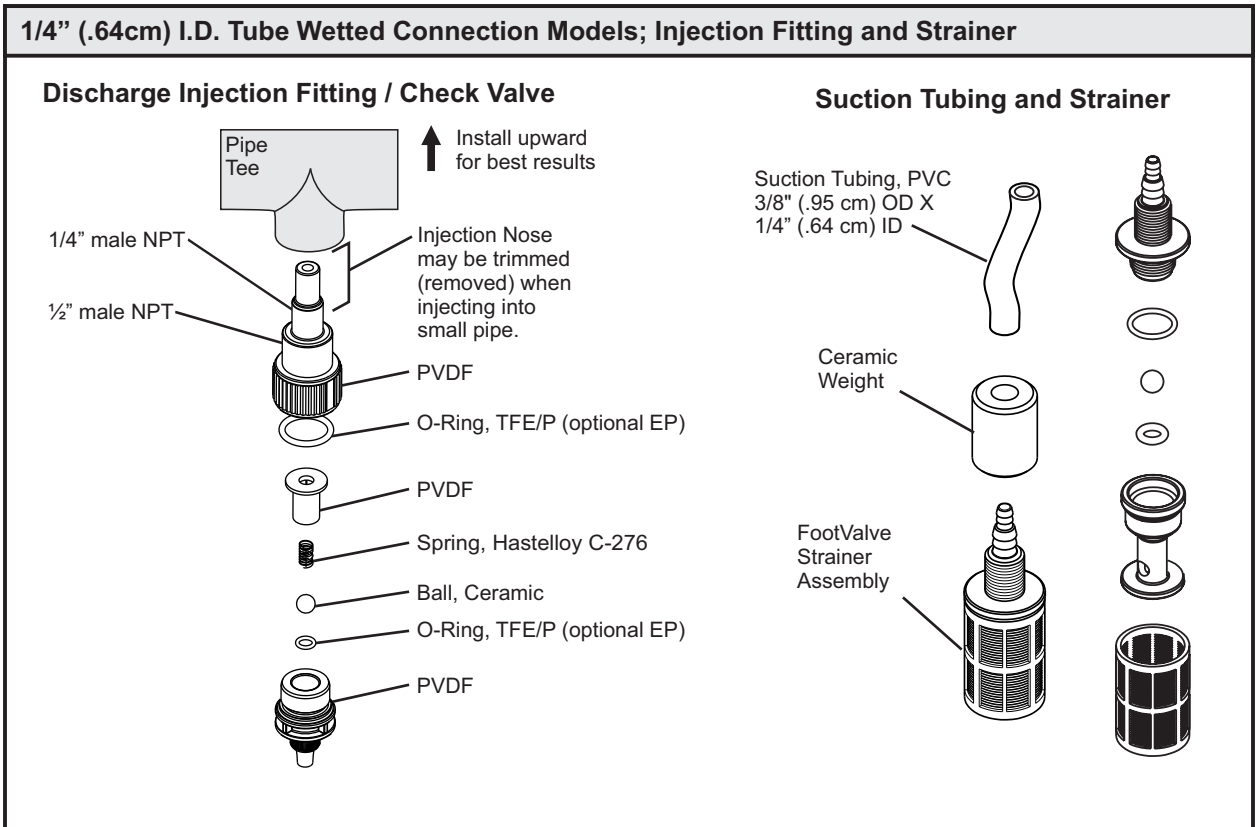
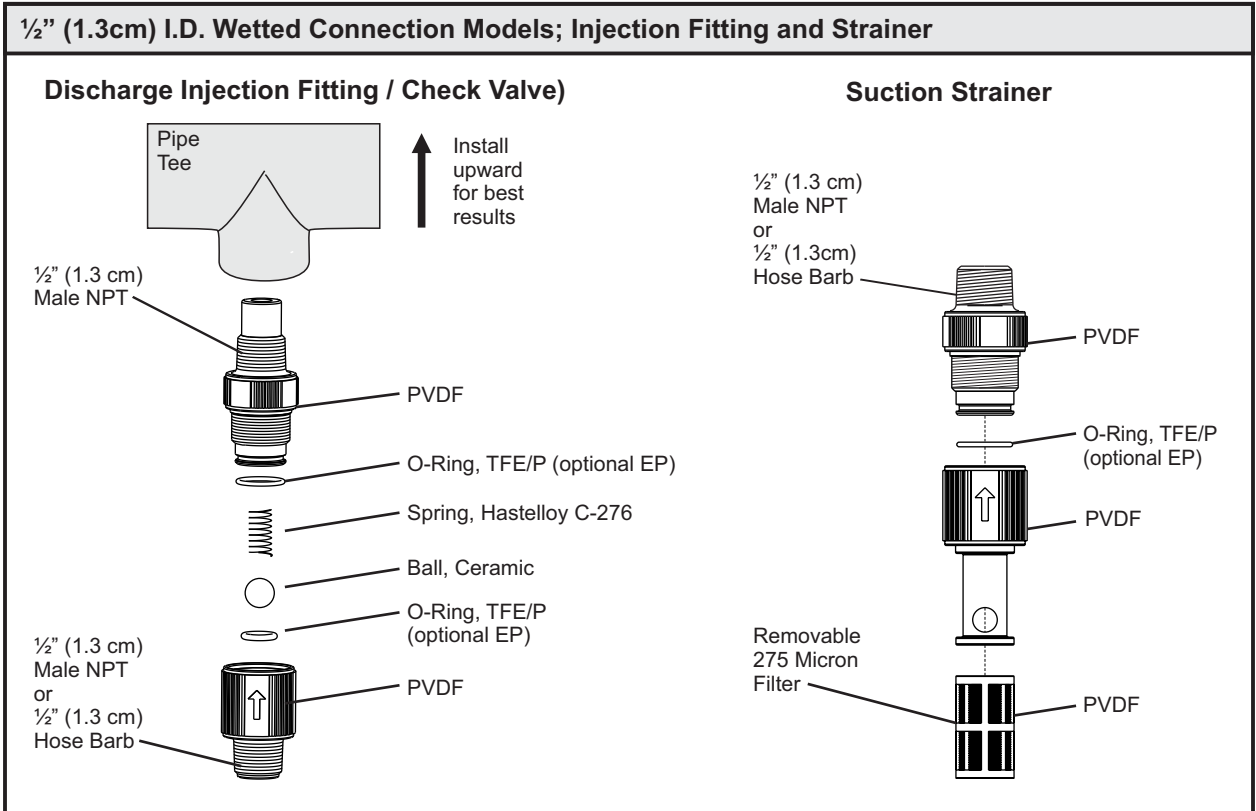

**CAUTION** Proper eye and skin protection must be worn when installing and servicing pump.

**CAUTION** This Pump Has Been Evaluated for Use with Water Only.





## 5.0 Power Connections

|   |  |
|---|--|
| <b>WARNING</b><br> | Risk of electric shock – cord connected models are supplied with a grounding conductor and grounding-type attachment plug. To reduce risk of electric shock, be certain that it is connected only to a properly grounded, grounding-type receptacle. |
| <b>WARNING</b><br> | Electrical connections and grounding (earthing) must conform to local wiring codes. Be certain that a grounding conductor is connected to terminal T11-1 located in wiring compartment.  |
| <b>WARNING</b><br> | Risk of electric shock - Disconnect electricity before removing wiring compartment cover.  |

Be certain to connect pump to proper supply voltage. Using incorrect voltage will damage pump and may result in injury. Voltage requirement is printed on pump serial label.

Input power: 115VAC 50/60 Hz 1.5 amp or 230/240VAC 50/60 Hz 0.7 amp.

Power switch located in Junction Box.

Use voltage your power cord is rated for.

Cord connected models are supplied with a ground wire conductor and a grounding type attachment plug (power cord). To reduce risk of electric shock, be certain that power cord is connected only to a properly grounded, grounding type receptacle.

Permanently connected models must be properly grounded. Be certain that a grounding conductor is connected to terminal T11-1 located in wiring compartment.

Never strap control (input / output) cables and power cables together.

**Power Interruption:** This pump has an auto-restart feature which will restore pump to operating state it was in when power was lost.

**Note:** When in doubt regarding your electrical installation, contact a licensed electrician.

### WIRING COMPARTMENT COVER

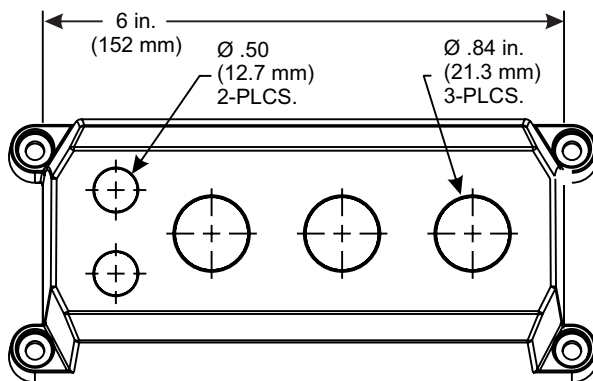

### POWER CORD OPTIONS

Four power cord plug types available.  
Power cord length is 6 feet (3.83 meters)



115V 60Hz  
NEMA 5/15 (USA)  
max: 125V AC

230V 60Hz  
NEMA 6/15 (USA)  
max: 250V AC

240V 50Hz  
CEE 7/VII (EU)  
max: 250V AC

### Included cable and conduit connectors:

| QTY.   | DESCRIPTION   |
|--------|---|
| Qty: 2 | - .50 Inch (12.7 Mm) Liq-tight Hole Plugs (mat'l = Neoprene), Pre-installed   |
| Qty: 2 | - .875 Inch (22.2 Mm) Liq-tight Hole Plugs (mat'l = Neoprene), 2 Pre-installed  |
| Qty: 2 | - .50 Inch (12.7 Mm) Liq-tight Connectors For Pass Thru Cords (mat'l = Nylon)<br>Acceptable Cable Diameter .118 To .255 Inch (3.0 To 6.5 Mm), Not Installed                             |
| Qty: 2 | - .875 Inch (22.2 Mm) Liq-tight Connectors For Pass Thru Cords (mat'l = Nylon)<br>Acceptable Cable Diameter .200 To .395 Inch (5.1 To =10.0 Mm), 1 Pre-installed With Power Cord Models |
| Qty: 1 | - Metallic Liq-tight Connectors For .50 Inch Flexible Conduit (mat'l = Die Cast Zinc), Not Installed  |



### 5.1 Wiring Terminals and I/O Schematics

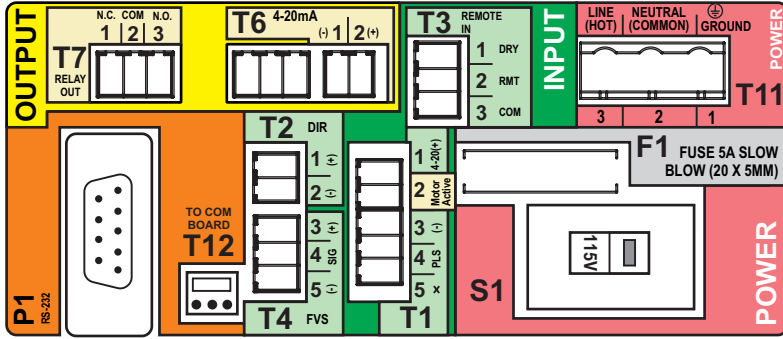

**WARNING** Risk of electric shock - All wiring must be insulated and rated 300V minimum.

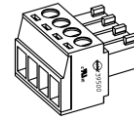

Terminals T1 Thru T8  
Plug type  
16 - 24 AWG

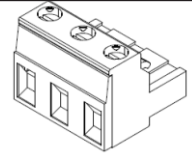

Power Input Terminal T11  
Plug type  
14 - 30 AWG

Shielded cables should be used on all input signal wires.

| FUNCTION   | TERM | PIN # | RATING       | ELECTRICAL SP.   | BLOCK DIAGRAM |
|--|------|-------|--------------|--|---------------|
| INPUT:<br>FVS SYSTEM<br>(FLOW VERIFICATION<br>SENSOR)<br>FV SENSOR ONLY                        | T4   | 3     | (+) POSITIVE |  |               |
|  | T4   | 4     | SIGNAL       |  |               |
|  | T4   | 5     | (-) NEGATIVE |  |               |
| INPUT:<br>FVS SYSTEM<br>(FLOW VERIFICATION<br>SENSOR)<br>FS or FP MICRO-FLO<br>FLOW METER ONLY | T4   | 4     | SIGNAL       |  |               |
|  | T4   | 5     | (-) NEGATIVE |  |               |
|  |      |       |              |  |               |
| INPUT:<br>REMOTE<br>START / STOP<br>(DRY CONTACT C.)   | T3   | 1     | (+) POSITIVE | NO VOLTAGE   |               |
|  | T3   | 2     | (-) NEGATIVE |  |               |
| INPUT:<br>REMOTE<br>START / STOP<br>(WET CONTACT C.)   | T3   | 2     | (+) POSITIVE | 6 TO 30 VOLT DC<br>1 AMP MAX.                                    |               |
|  | T3   | 3     | (-) NEGATIVE |  |               |
| OUTPUT:<br>RELAY, 3 AMP  | T7   | 1     | NORM. CLOSED | Form C<br>3 AMP MAX AT<br>250 VAC,<br>3 AMP MAX AT<br>30 VOLT DC |               |
|  | T7   | 2     | COMMON       |  |               |
|  | T7   | 3     | NORM. OPEN   |  |               |
| INPUT:<br>POWER  | T11  | 1     | GROUND       | 115V OR 230V AC<br>MANUAL SWITCH<br>50 / 60 HZ<br>100W           |               |
|  | T11  | 2     | NEUTRAL      |  |               |
|  | T11  | 3     | LINE (HOT)   |  |               |
| FUSE   | F1   | N/A   | 5 AMP        | 5A SLOW BLOW<br>(20 X 5MM)                                       |               |

## 6.0 How to Operate Chem-Pro® - Control Pad



### Press and release

Press UP arrow to increase pump speed (output) in Manual Operation.  
To increase value while in programming mode.



### Press and release

Press DOWN arrow to decrease pump speed (output) in Manual Operation.  
To decrease value while in programming mode.



### Press and release

To Stop pump at any time.

### Press and release

To Start pump.  
To begin listening (reacting) to external signal, such as Remote Start/Stop.



### Press and hold

To enter programming mode.

- Remote Start/Stop setup
- FVS (flow verification sensor) setup

### Press and release

To save setting while in programming mode.  
To move to **next** selection while in programming mode.



### Press and release

To prime pump (60 seconds) – See page 17

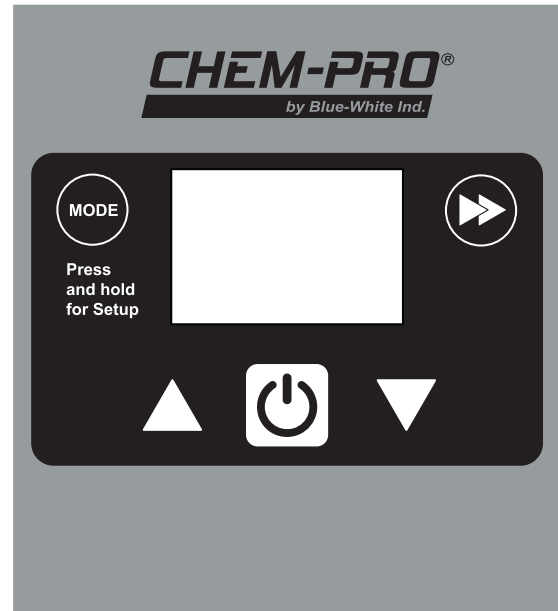

**Time-out** - Chem-Pro® pumps have a time-out setting of approximately 20 seconds while in configuration menu. If built-in timer exceeds 20 seconds without a button being pressed, then pump will exit configuration menu. Changes will only be saved after START | STOP button is pressed and released.



## 7.0 Set Remote Start / Stop

Used to remotely start and stop pump using a dry contact closure signal.  
When activated; CLOSE = START and OPEN = STOP.

Set to NO = Remote Start / Stop is disabled  
Set to Yes = Remote Start / Stop is enabled

Can be used with external foot pedal, PLC, contact closure or other similar external devices.

Default setting = No (disabled)

### Step 1

Press and release STOP button

Note: Cannot enter programming mode while pump is running.



### Step 2

Press and hold START | STOP button until 'Remote' icon begins flashing.

Default setting 'NO' will also be visible when entering remote start / stop setup.

Note: If 'YES' had been selected previously, then 'YES' will be displayed on screen.

Remote  
Icon



### Step 3

Press and release DOWN arrow to change setting to 'YES.'

To change setting back to 'NO' press and release UP arrow.



### Step 4

After you've made your selection, press and release START | STOP button. This saves your setting.

You can now modify FVS setting (see next page) or you can exit Setup by pressing and holding START | STOP button for a few seconds until you return to Run screen.



Running pump with Remote Start / Stop enabled, 'REMOTE' icon will always be visible on lower left side of screen.  
Pump will display 'STBY' (standby) if pump is in stop mode via contact closure signal. **Please use caution in this mode, pump can start at anytime. If you must perform maintenance to pump, press and release STOP button.**

## 7.1 Set FVS (flow verification system)

Flow verification sensor sold separately.

Flow verification system is designed to stop pump in an event sensor does not detect flow during pump operation. Indicating an empty chemical tank, clogged injection fitting, loose tubing connection, etc.

To allow pump to clear any gasses that may have accumulated over time, an alarm delay time value from 1 to 255 seconds must be programmed.

Note: An alarm delay of 000 seconds disables FVS system.

### Step 1

Press and release STOP button

Note: Cannot enter programming mode while pump is in running.



### Step 2

Press and hold START | STOP button until 'Remote' icon begins flashing.

This indicates that you've entered Setup menu.

Remote  
Icon



### Step 3

Press and release START | STOP button to scroll through menu until you see FVS icon.

If you pass FVS screen, continue to press and release START | STOP button until FVS icon appears.



### Step 4

FVS icon will appear for 1 second, followed by numbers.

These numbers indicate delay time setting for FVS.

Select a delay time in seconds. Delay time is amount of time pump will wait to receive a pulse from sensor until an alarm is triggered.

A delay time of 00 deactivates FVS feature.



### Step 5

After you've made your selection, press and release START | STOP button. This saves your setting.

Press and hold START | STOP button to exit Setup menu and return to runtime screen.



**Time-out** - Chem-Pro pumps have a time-out setting of 20 seconds while in configuration menus. If built-in timer exceeds 20 seconds without a button being pressed, then pump will exit configuration menu. Changes will only be saved after RIGHT arrow button is pressed and released.

## 7.1 Set FVS (flow verification system) - Continued

Flow Verification Sensor is designed to give you two installation options.

Sensor can be installed:

- Directly onto pumphead of Chem-Pro® pump, discharge side.
- Anywhere on discharge side of Chem-Pro® pump.

Wiring for sensor can be connected directly to a Chem-Pro® pump. Pump will stop pumping if sensor detects no flow. A relay will then close allowing for remote alarm indication or initiation of a back-up pump. **Install FVS Flow Sensor** - Flow Verification Sensor should be installed on inlet (suction) side of pump tube.

When installing directly onto pump 3/8" tube discharge fitting:

Sensor includes a PVC tubing insert, located inside sensors female thread connection, that is designed to seal sensor onto pump tube adapter. Thread sensor onto pump tube until tubing insert is snug against pump tube fitting - do not over-tighten.

| Sensor Model Number | Published Flow Range | Actual Working Range with Chem-Pro® Pump |
|---------------------|----------------------|--|
|                     | ML/Min               | ML/Min                                   |
| FV-100              | 30-300               | 30-200                                   |
| FV-200              | 100-1000             | 50-900                                   |
| FV-300              | 200-2000             | 100-1800                                 |
| FV-400              | 300-3000             | 300-3000                                 |
| FV-500              | 500-5000             | 500-5000                                 |
| FV-600              | 700-7000             | 700-7000                                 |

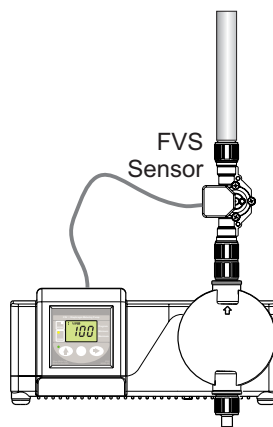

**Confirm FVS flow range** - Flow Verification Sensor (FVS) will only function within its operating range. See chart for available ranges.

NOTE: If pump output is less than 30 ml/min, sensor will not detect chemical and a signal will not be sent to pump, resulting in an alarm condition.

NOTE: For low viscosity (water-like) fluids only. Consult factory if attempting to use with viscous fluids.

## 8.0 Manual Operation

Used to manually control speed of pump.

Use UP and DOWN arrows to adjust speed while pump is running.

To select exact run speed, follow steps below.

### Runtime Screen Shot 1

Displays motor speed percentage.  
Pump Running in Manual Operation

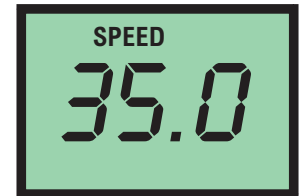

### Runtime Screen Shot 2

Displays motor speed percentage.  
Pump Running in Manual Operation with Remote Start /  
Stop enabled (see page 11).

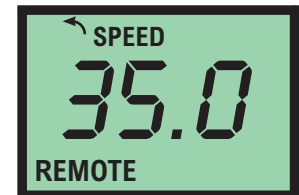

### Runtime Screen Shot 3

Displays 'Stand-By' status with Remote start/stop enabled  
and waiting for signal to start.

**Caution**, pump can start up at anytime in this condition.  
Press STOP button before performing maintenance.

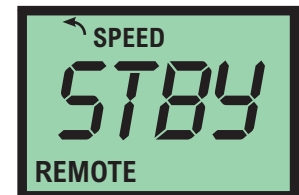

With pump operating in manual operation, pump speed can be changed at anytime by using UP or DOWN arrows during operation.

## 9.0 DFD (Diaphragm Failure Detection)

Chem-Pro® is equipped with a Diaphragm Failure Detection System which is designed to stop pump and provide an output alarm in event diaphragm should rupture and chemical enters pump head. Pump will detect a chemical with a conductivity reading greater than 500 microsiemens. Chemicals with a conductivity of less than 500 microsiemens will not be detected.

This system is capable of detecting presence of a large number of chemicals including Sodium Hypochlorite (Chlorine), Hydrochloric (muriatic) Acid, Sodium Hydroxide, and many others. System will not be triggered by water (rain, condensation, etc.) or lubricants.

If system has detected chemical, pump diaphragm must be replaced and pump head must be thoroughly cleaned. Failure to clean pump head will void warranty.

If DFD alarm occurs, pump will stop, close an alarm output, and screen will flash DFD with an alarm icon.

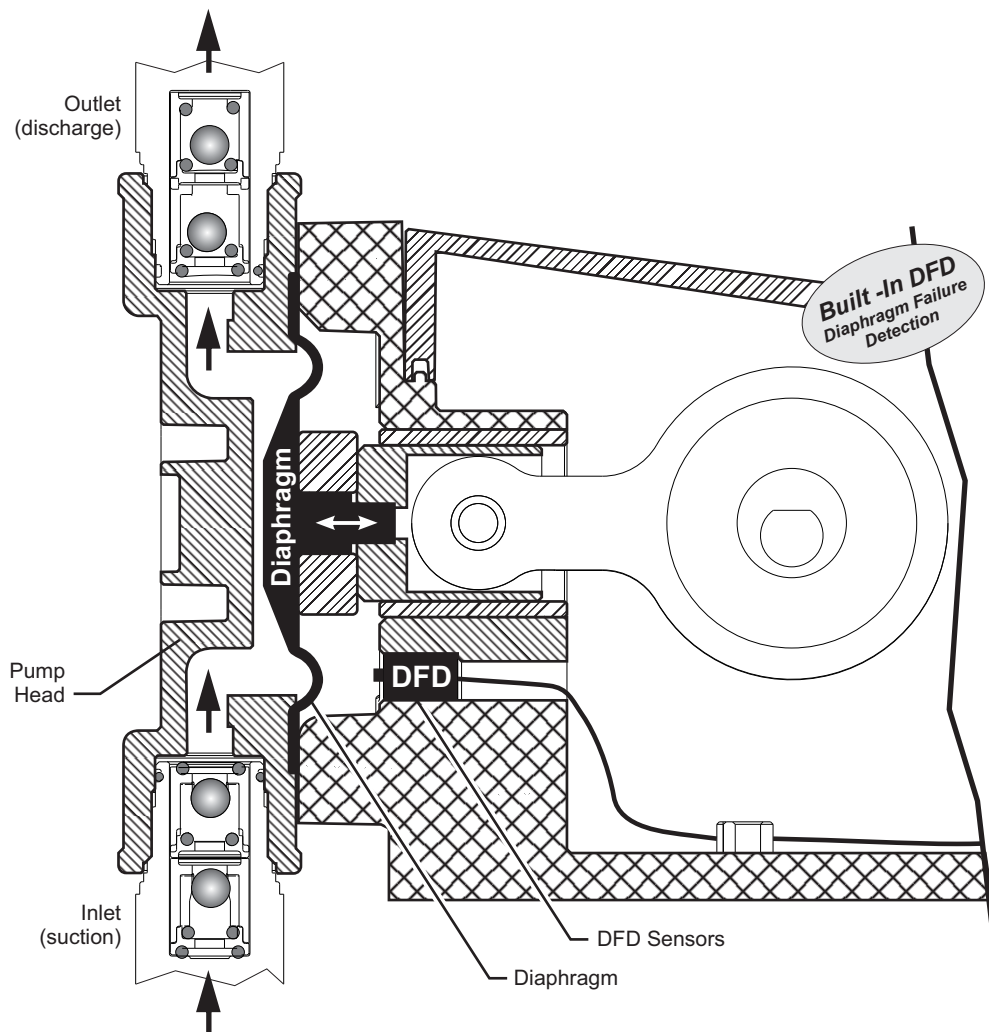



## 10.0 Alarm Relay

Pump has a built in 3 amp alarm output relay. Relay is pre-configured to energize on diaphragm failure detection (DFD) and on Flow Verification Sensor (FVS).

A Flow Verification Sensor must be installed and configured for relay to trigger on no-flow conditions. See page 9 for wiring details.

## 11.0 Volumetric Test - Measuring Chem-Pro's Output

This volumetric test will take into account individual installation factors such as line pressure, fluid viscosity, suction lift, etc. This test is most accurate for measuring injector's output in an individual installation.

1. Be sure Injection Fitting and Footvalve / Strainer are clean and working properly.
2. Fill a large graduated cylinder with solution to be injected.
3. With pump installed under normal operating conditions, place suction tubing with Footvalve / Strainer installed in graduated cylinder.
4. Run pump until all air is removed from suction line and solution enters discharge tubing.
5. Remove suction tubing from graduated cylinder and refill graduated cylinder if necessary. Note amount of solution in graduated cylinder.
6. Place suction tubing with Footvalve / Strainer installed back into graduated cylinder.
7. Run injector for a measured amount of time. A longer testing time will produce more accurate results.
8. Remove suction tubing from graduated cylinder. Measure amount of chemical injected.

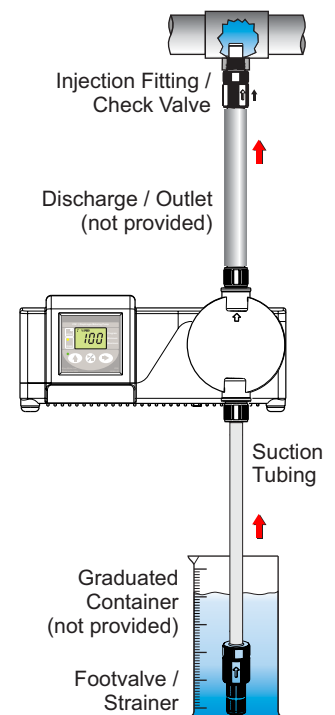

### Example:

During your 1 minute calibration period, say Chem-Pro pumped 1000 Milliliters in 1 minute.

$$1 \text{ US Gallon} = 3.785 \text{ Liters} = 3785 \text{ Milliliters}$$



$$\left( \frac{1000 \text{ ML/Min}}{3785} \right) 60 = 15.85 \text{ GPH (US gallons per hour)}$$

Minutes per hour

Milliliters in a US gallon

**Note:** All diagrams are strictly for guideline purposes only. Always consult an expert before installing pump into specialized systems. Pump should be **serviced by qualified persons only.**

## 12.0 Pump Maintenance

|   |   |
|---|---|
| <b>CAUTION</b><br> | Prior to service, pump clean water through pump and suction / discharge line to remove chemical.  |
| <b>CAUTION</b><br> | Always wear protective clothing, face shield, safety glasses and gloves when working on or near your metering pump. Additional precautions should be taken depending on solution being pumped. Refer to MSDS precautions from your solution supplier. |

### 12.1 Routine Inspection and Maintenance

Pump requires very little maintenance. However, pump and all accessories should be checked weekly. This is especially important when pumping chemicals. Inspect all components for signs of leaking, swelling, cracking, discoloration or corrosion. Replace worn or damaged components immediately.

Cracking, crazing, discoloration during first week of operation are signs of severe chemical attack. If this occurs, immediately remove chemical from pump. Determine which parts are being attacked and replace them with parts that have been manufactured using more suitable materials. Manufacturer does not assume responsibility for damage to pump that has been caused by chemical attack.

Brush Kit Life Cycle over 3,000 hours of continuous use. A spare brush kit is located inside of pump housing.

### 12.2 Cleaning Pump

Pump will require occasional cleaning, especially Injection fitting, Footvalve / Strainer, and pump head valves. Frequency will depend on type and severity of service.

- ✓ Inspect and replace pump head valves as required.
- ✓ When changing diaphragm, pump head chamber and pump head cover should be wiped free of any dirt and debris. The pump stroke must be FORWARD when screwing in the diaphragm and BACKWARD when installing and tightening the pump head.
- ✓ Periodically clean injection / check valve assembly, especially when injecting fluids that calcify such as sodium hypochlorite. These lime deposits and other build ups can clog fitting, increase back pressure and interfere with check valve operation.
- ✓ Periodically clean suction strainer.
- ✓ Periodically inspect pump housing (enclosure) for chemical attack. Protect pump housing from continuous exposure to chemicals, such as drips or fumes from surrounding equipment and plumbing.

## 12.3 Motor Brush Replacement

Brushes wear differently on each side of motor. It is recommended to replace both brushes at the same time.

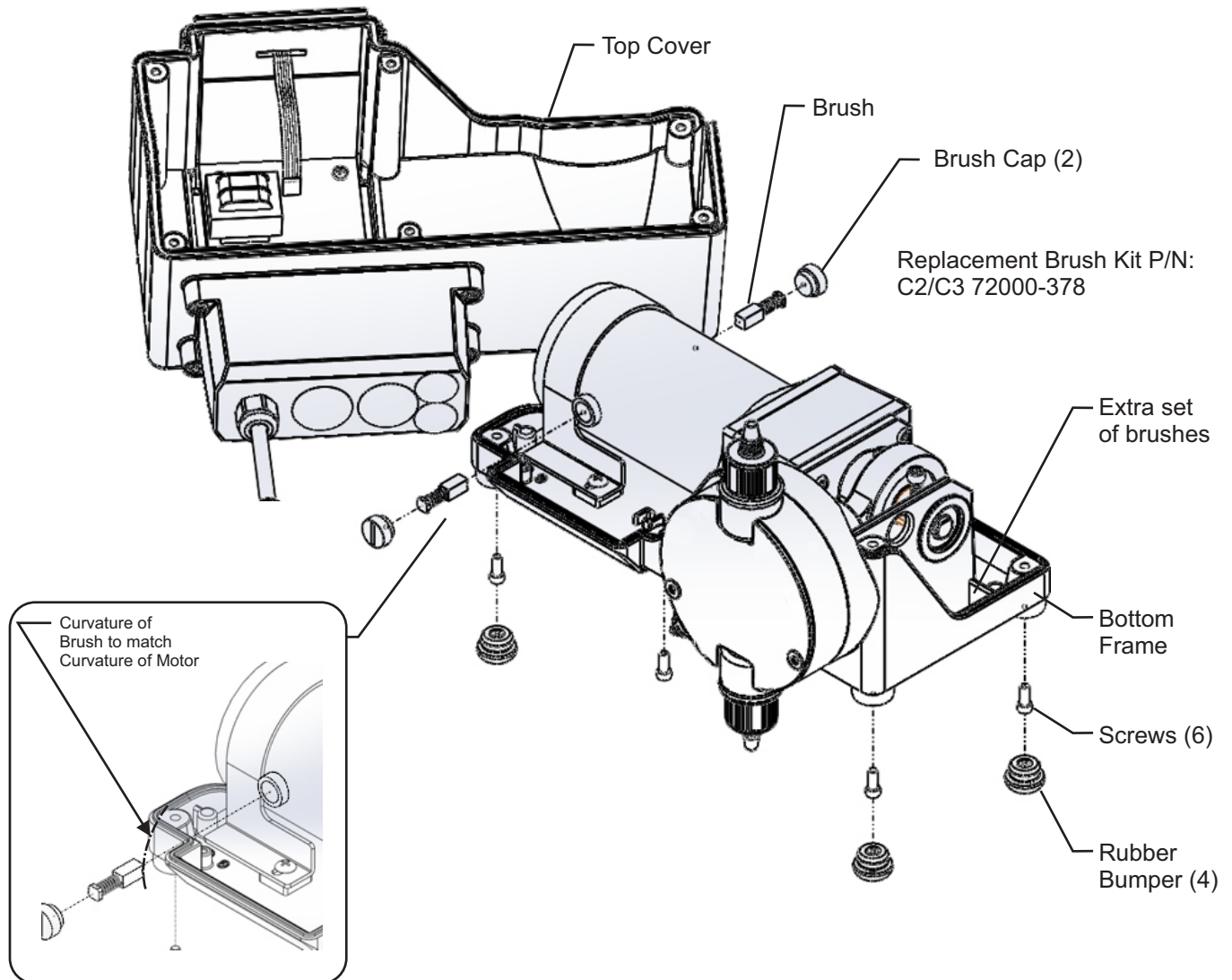

### Step 1

Remove 4 black rubber bumpers from bottom frame.

### Step 2

Remove 6 screws from underneath side of bottom frame.

### Step 4

Lift off top cover from bottom frame carefully. Place top cover close to bottom frame.

*Please Note:* Wires connecting top and bottom may become unplugged if pulled too far apart.

### Step 5

Unscrew and remove brush caps by turning counter-clockwise.

### Step 6

Remove used brushes and discard properly.

### Step 7

Insert new brushes. Be sure to install brushes to that curvature of brush is concentric to curvature of motor. Please note: One extra set of brushes are provided inside frame.

### 13.0 Output Versus Pressure

#### 13.1 C2 Output V. Pressure

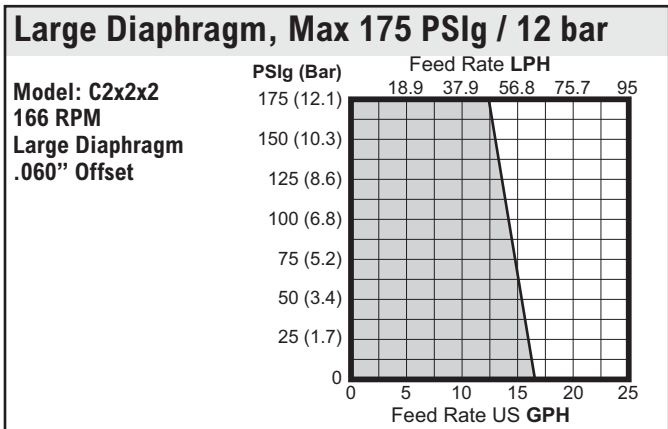
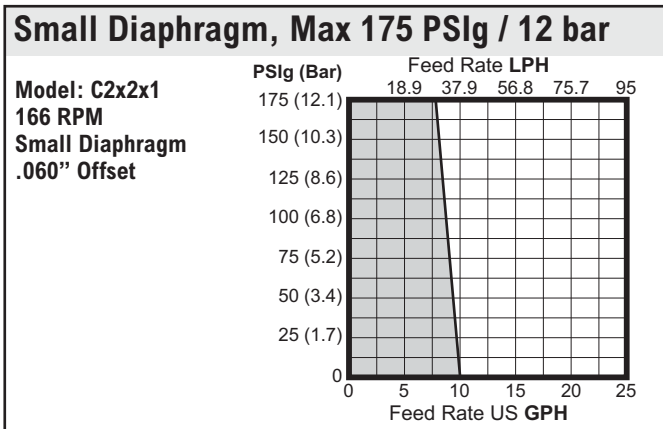
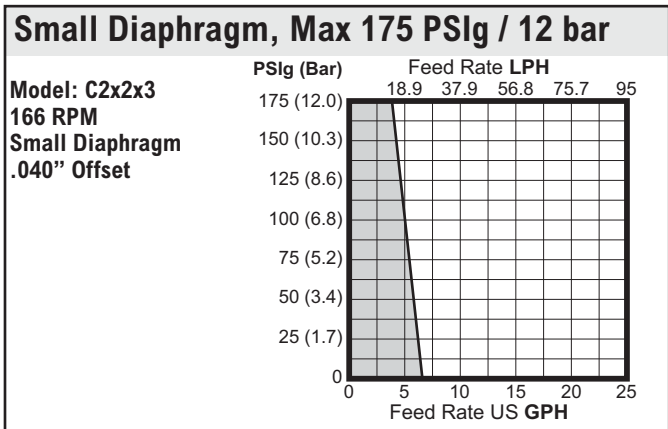
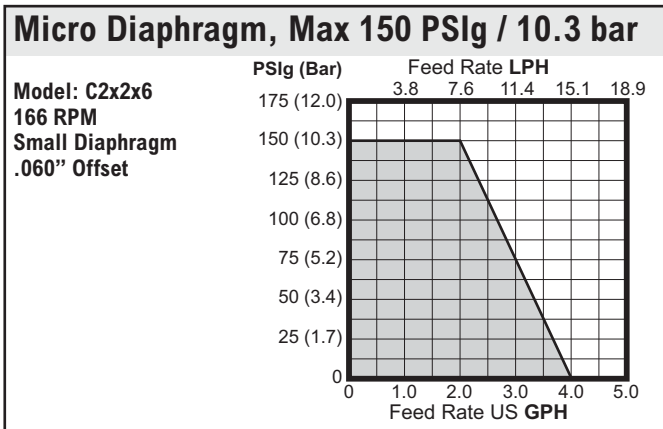
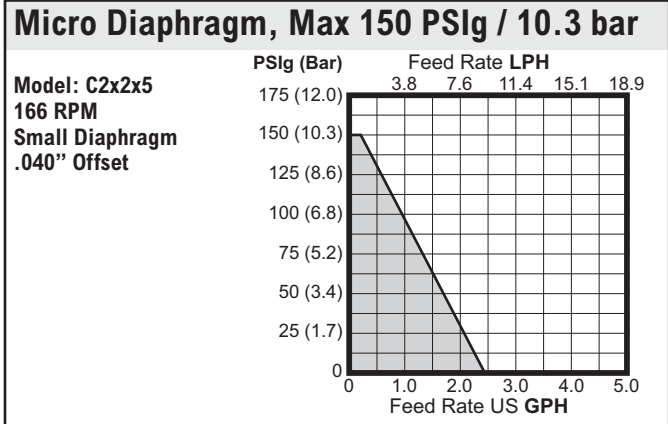

#### 13.2 C3 Output V. Pressure

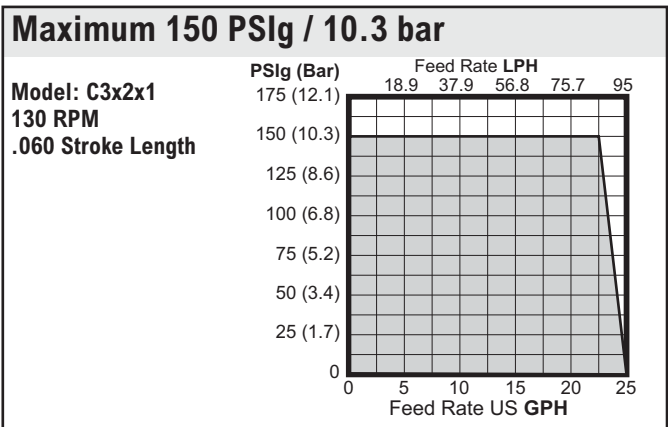
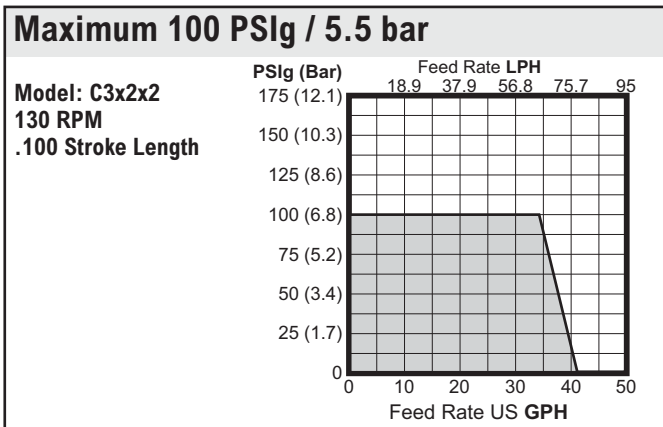

## 14.0 Replacement Parts List

### 14.1 C2 Parts List

| ITEM | PART NO.  | DESCRIPTION                | QTY REQ. |
|------|-----------|----------------------------|----------|
| 1    | 90011-081 | SCREW 6-32 X .5            | 2        |
| 2    | 90001-170 | COVER P/H C2               | 1        |
|      | 90001-171 | COVER P/H NO LOGO          | 1        |
| 3    | 90011-181 | SCREW 10X32 X 1.25         | 8        |
| 6    | 71010-446 | P/HEAD MICRO C2 PVDF       | 1        |
|      | 90002-273 | P/HEAD SM C2 PVDF          |          |
|      | 90002-272 | P/HEAD LG C2 PVDF          |          |
| 7    | 70001-349 | VALVE .5 M/NPT VIT         | 2        |
|      | 70001-350 | VALVE .5 M/NPT EP          |          |
|      | 70001-351 | VALVE .5 F/NPT VIT         |          |
|      | 70001-352 | VALVE .5 F/NPT EP          |          |
|      | 70001-347 | VALVE .5 T-BARB VIT        |          |
|      | 70001-348 | VALVE .5 T-BARB EP         |          |
|      | 70001-372 | VALVE .375 TUBE VIT        |          |
|      | 70001-373 | VALVE .375 TUBE EP         |          |
| 8    | 20000-194 | KIT 4 EA. VALVE VIT        | 1        |
|      | 20000-195 | KIT 4 EA. VALVE EP         |          |
| 9    | 72000-551 | MICRO DIAPHRAGM KIT        | 1        |
|      | 72000-296 | SMALL DIAPHRAGM KIT        |          |
|      | 72000-297 | LARGE DIAPHRAGM KIT        |          |
|      | 72000-606 | MICRO DIA KIT FLEX-A-PRENE |          |
|      | 72000-607 | SM DIA KIT FLEX-A-PRENE    |          |
|      | 72000-605 | LG DIA KIT FLEX-A-PRENE    |          |
| 11   | 90001-173 | P/HEAD LG. SPACER          | 1        |
|      | 90001-172 | P/HEAD SM. SPACER          |          |
| 13   | 90003-561 | BUMPER FEET                | 4        |
| 14   | 90002-326 | UV LCD CVR PLYCRB          | 1        |
| 16   | 71010-027 | J-BOX KIT W/ 115V          | 1        |
|      | 71010-028 | J-BOX KIT W/ 230V          | 1        |
|      | 71010-029 | J-BOX KIT W/ 220V          | 1        |
| 21   | 71000-575 | FOOTVALVE .5 T CR VIT      | 1        |
|      | 71000-447 | FTVALVE .5 CR VT/AF NO SP  |          |
|      | 71000-325 | FOOTVALVE .5 CR EP NO SP   |          |
| 22   | 90008-043 | CLAMP SS .5"               | 1        |

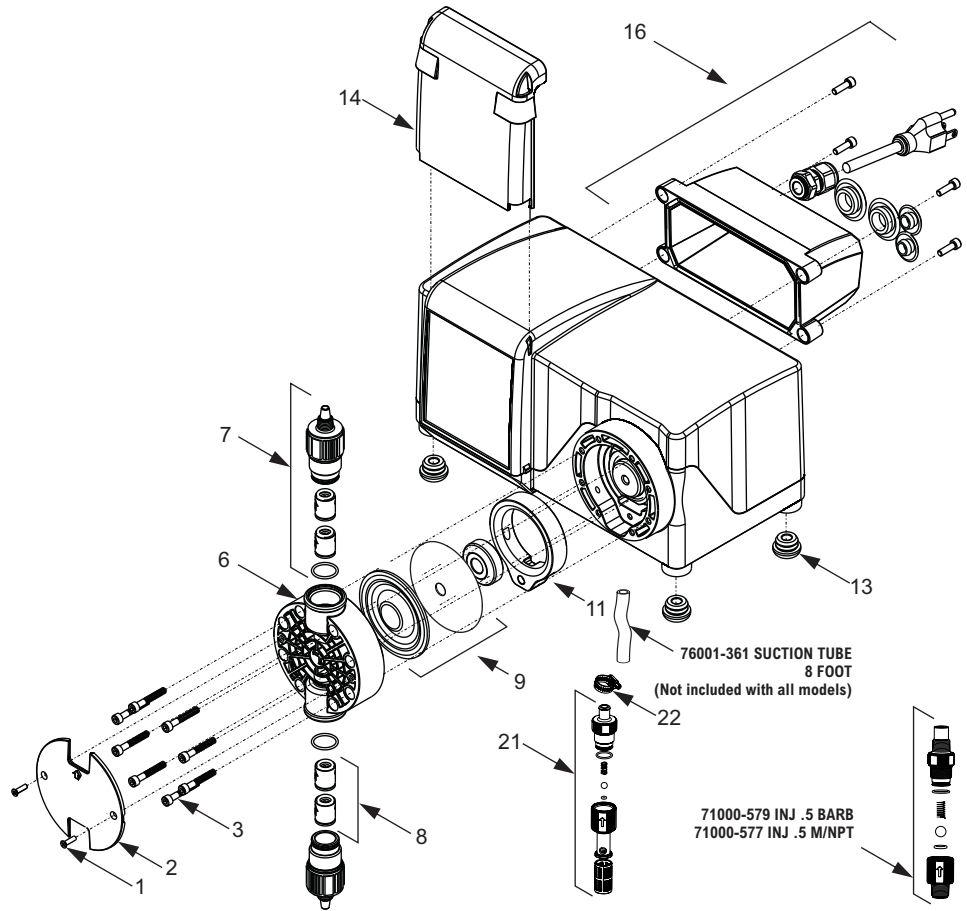

14.2 C3 Parts List

| ITEM | PART NO.  | DESCRIPTION                | QTY REQ. |
|------|-----------|----------------------------|----------|
| 1    | 90011-081 | SCREW 6-32 X .5            | 2        |
| 2    | 90001-157 | COVER P/H C3               | 1        |
|      | 90001-158 | COVER P/H C3 NO LOGO       | 1        |
| 3    | 90011-181 | SCREW 10X32 X 1.25         | 8        |
| 4    | 90011-094 | WASHER #10 P/H SS          | 8        |
| 6    | 90002-258 | P/HEAD LG C3 PVDF          | 1        |
| 7    | 70001-349 | VALVE .5 M/NPT VIT         | 2        |
|      | 70001-350 | VALVE .5 M/NPT EP          |          |
|      | 70001-351 | VALVE .5 F/NPT VIT         |          |
|      | 70001-352 | VALVE .5 F/NPT EP          |          |
|      | 70001-347 | VALVE .5 T-BARB VIT        |          |
|      | 70001-348 | VALVE .5 T-BARB EP         |          |
| 8    | 20000-194 | KIT 4 EA. VALVE VIT        | 1        |
|      | 20000-195 | KIT 4 EA. VALVE EP         |          |
| 9    | 72000-295 | DIAPHRAGM. KIT C3          | 1        |
|      | 72000-604 | DIAPHRAGM KIT FLEX-A-PRENE |          |
| 13   | 90003-561 | BUMPER FEET                | 4        |
| 14   | 90002-326 | UV LCD CVR PLYCRB          | 1        |
| 16   | 71010-027 | J-BOX KIT W/ 115V          | 1        |
|      | 71010-028 | J-BOX KIT W/ 230V          | 1        |
|      | 71010-029 | J-BOX KIT W/ 220V          | 1        |
| 21   | 71000-575 | FOOTVALVE .5 T CR VIT      | 1        |
|      | 71000-447 | FTVALVE .5 CR VT/AF NO SP  |          |
|      | 71000-325 | FOOTVALVE .5 CR EP NO SP   |          |
| 22   | 90008-043 | CLAMP SS .5"               | 1        |
| * 23 | 76001-361 | TUBE SUCTION .5 D, 8' L    | 1        |
| 24   | 71000-579 | INJECTION .5 BARB          | 1        |
|      | 71000-577 | INJECTION .5 M/NPT         |          |

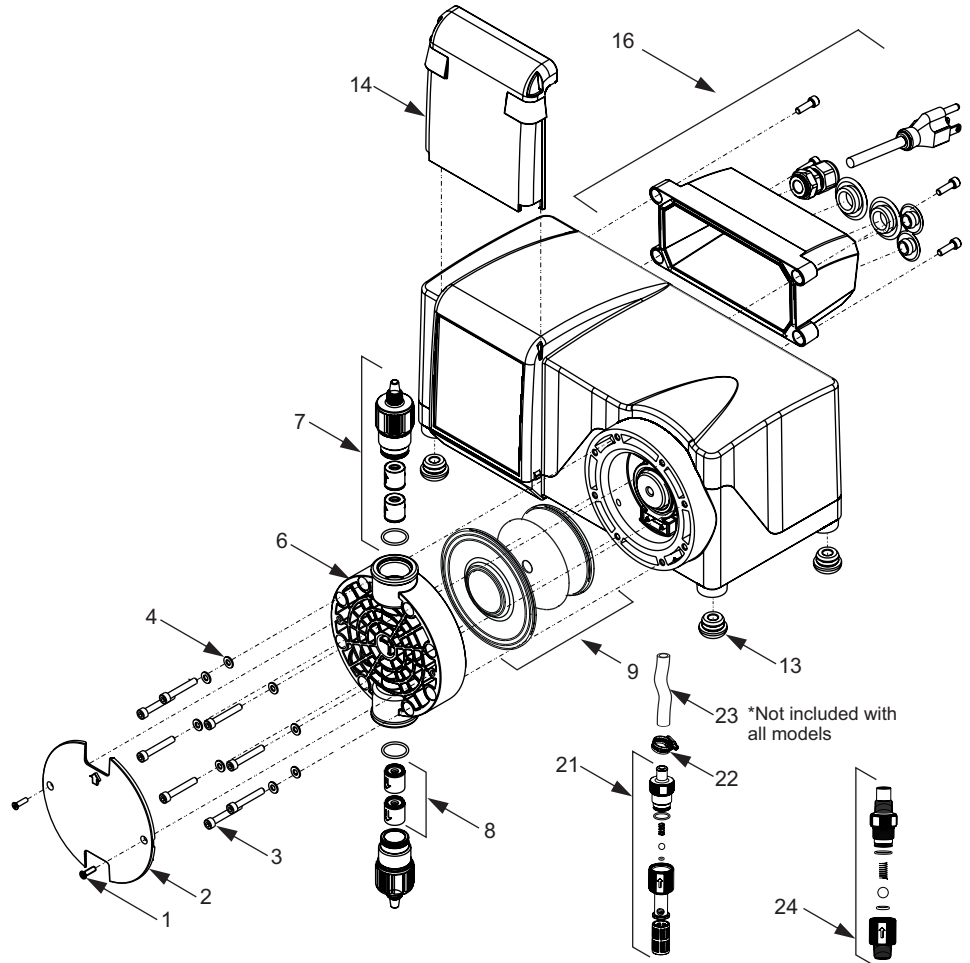

# Typical Installation

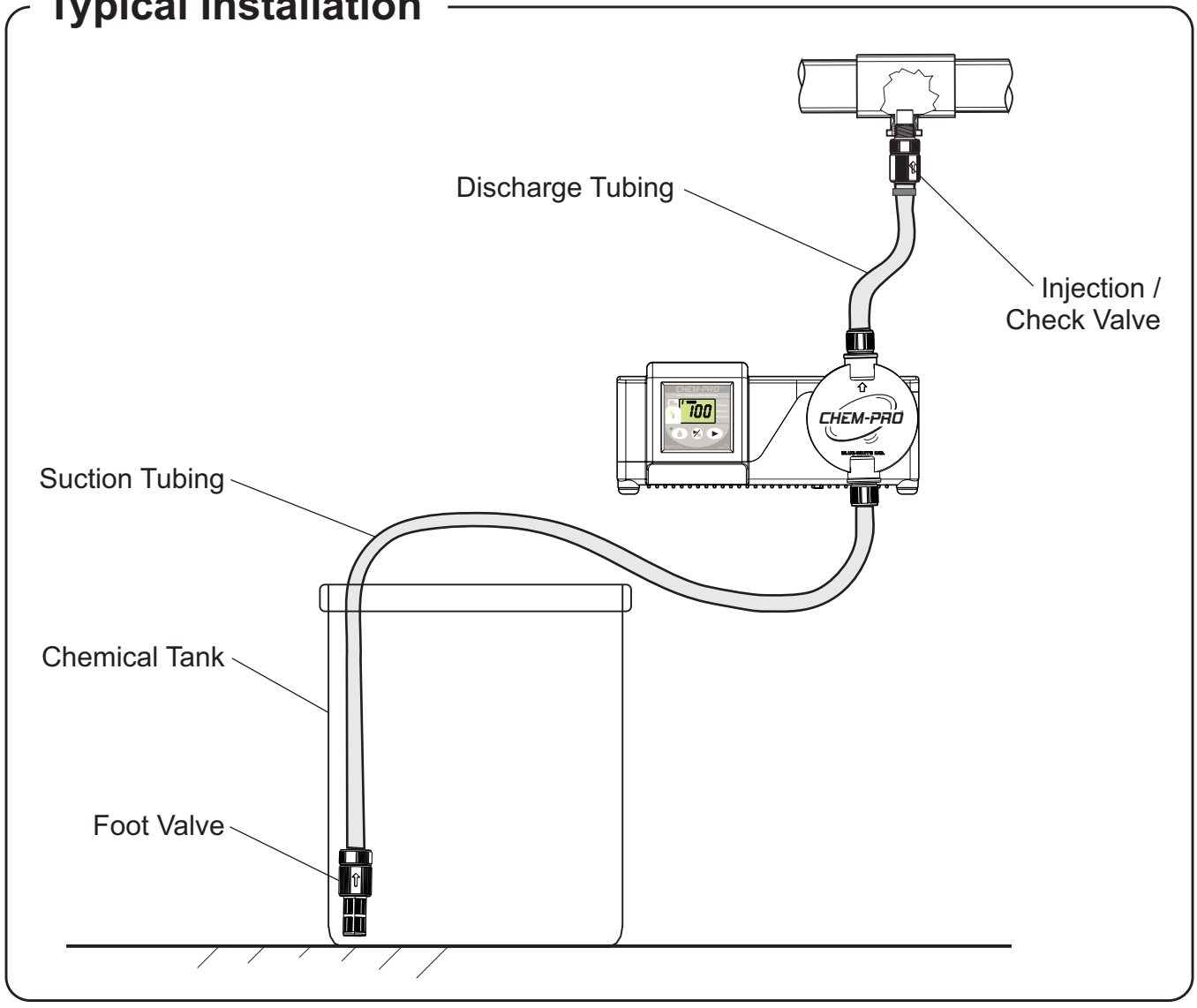



## 15.0 WARRANTY

### 15.1 Limited Warranty

The pump is a quality product and is warranted for 24 months from date of purchase (proof of purchase is required). The pump will be repaired or replaced at our discretion. The pump head and roller assembly are warranted against damage from a chemical attack when the proper Diaphragm Failure Detection(DFD+) system instructions and maintenance procedures are followed.

### 15.2 What is not Covered

- **Pump diaphragm and rubber components - They are perishable and require periodic replacement**
- **Pump removal, or re-installation, and any related labor charge.**
- **Freight to the factory.**
- **Pumps that have been tampered with, or in pieces.**
- **Damage to the pump that results from misuse, carelessness (such as chemical spills) on the enclosure, abuse, lack of maintenance, or alteration that is out of Blue-White Industries, Ltd.'s control.**
- **Pumps damaged by faulty wiring, power surges, or acts of nature.**

Blue-White Industries, Ltd. does not assume responsibility for any loss, damage, or expense directly or indirectly related to or arising out of the use of its products. Failure must have occurred due to defect in material or workmanship and not as a result of operation of the product other than in normal operation as defined in the pump operation manual.

The warranty status is determined by the pump's serial label and the sales invoice or receipt. The serial label must be on the pump and be legible. The warranty status of the pump will be verified by Blue-White Industries, Ltd. or a factory authorized service center.

### 15.3 Obtaining In-Warranty Repair

Contact the factory to obtain a RMA (Return Material Authorization) number. Carefully pack the pump to be repaired. It is recommended to include foot strainer and injection/check valve fitting since these devices may be clogged and part of the problem. Please enclose a brief description of the problem as well as the original invoice or sales receipt, or copy showing the date of purchase. Prepay all shipping costs. COD shipments will not be accepted. Warranty service must be performed by the factory or an authorized ProSeries service center. Damage caused by improper packaging is the responsibility of the sender. When In-Warranty repair or replacement is completed, the factory pays for return shipping to the dealer or customer.

### 15.4 Product Use Warning

Blue-White products are manufactured to meet the highest quality standards in the industry. Each product instruction manual includes a description of the associated product warranty and provides the user with important safety information. Purchasers, installers, and operators of Blue-White products should take the time to inform themselves about the safe operation of these products. In addition, Customers are expected to do their own due diligence regarding which products and materials are best suited for their intended applications. Blue-White is pleased to assist in this effort but does not guarantee the suitability of any particular product for any specific application as Blue-White does not have the same degree of familiarity with the application that the customer/end user has. While Blue-White will honor all of its product warranties according to their terms and conditions, Blue-White shall only be obligated to repair or replace its defective parts or products in accordance with the associated product warranties. **BLUE-WHITE SHALL NOT BE LIABLE EITHER IN TORT OR IN CONTRACT FOR ANY LOSS OR DAMAGE WHETHER DIRECT, INDIRECT, INCIDENTAL, OR CONSEQUENTIAL, ARISING OUT OF OR RELATED TO THE FAILURE OF ANY OF ITS PARTS OR PRODUCTS OR OF THEIR NONSUITABILITY FOR A GIVEN PURPOSE OR APPLICATION.**

### 15.5 Chemical Resistance Warning

Blue-White offers a wide variety of wetted parts. Purchasers, installers, and operators of Blue-White products must be well informed and aware of the precautions to be taken when injecting or measuring various chemicals, especially those considered to be irritants, contaminants or hazardous. Customers are expected to do their own due diligence regarding which products and materials are best suited for their applications, particularly as it may relate to the potential effects of certain chemicals on Blue-White products and the potential for adverse chemical interactions.

Blue-White tests its products with water only. The chemical resistance information included in this instruction manual was supplied to Blue-White by reputable sources, but Blue-White is not able to vouch for the accuracy or completeness thereof. While Blue-White will honor all of its product warranties according to their terms and conditions, Blue-White shall only be obligated to repair or replace its defective parts or products in accordance with the associated product warranties.

**BLUE-WHITE SHALL NOT BE LIABLE EITHER IN TORT OR IN CONTRACT FOR ANY LOSS OR DAMAGE, WHETHER DIRECT, INDIRECT, INCIDENTAL, OR CONSEQUENTIAL, ARISING OUT OF OR RELATED TO THE USE OF CHEMICALS IN CONNECTION WITH ANY BLUE-WHITE PRODUCTS.**



Users of electrical and electronic equipment (EEE) with the WEEE marking per Annex IV of the WEEE Directive must not dispose of end of life EEE as unsorted municipal waste, but use the collection framework available to them for the return, recycle, recovery of WEEE and minimize any potential effects of EEE on the environment and human health due to the presence of hazardous substances. The WEEE marking applies only to countries within the European Union (EU) and Norway. Appliances are labeled in accordance with European Directive 2002/96/EC. Contact your local waste recovery agency for a *Designated Collection Facility* in your area.

**ProSeries<sup>®</sup>**  
by Blue-White Ind.

5300 Business Drive, Huntington Beach, CA 92649 USA

**Phone:** 714-893-8529 **FAX:** 714-894-9492

**E mail:** [sales@blue-white.com](mailto:sales@blue-white.com) or [techsupport@blue-white.com](mailto:techsupport@blue-white.com) **URL:** [www.blue-white.com](http://www.blue-white.com)